

UNCLASSIFIED

AD NUMBER

AD387363

CLASSIFICATION CHANGES

TO: unclassified

FROM: confidential

LIMITATION CHANGES

TO:
Approved for public release, distribution
unlimited

FROM:
Distribution: No foreign.

AUTHORITY

Group-4 DoDD 5200.10, 26 Jul 1962; OAG,
D/A ltr., 29 Apr 1980

THIS PAGE IS UNCLASSIFIED



CONFIDENTIAL

**DEPARTMENT OF THE ARMY
OFFICE OF THE ADJUTANT GENERAL
WASHINGTON, D.C. 20310**

IN REPLY REFER TO

AGAM-P (M) (31 Jan 68) FOR OT RD-670701

6 February 1968

SUBJECT: Operational Report - Lessons Learned, Headquarters, 3d Brigade,
25th Infantry Division, Period Ending 31 July 1967

TO: SEE DISTRIBUTION

AD 387363

1. Subject report is forwarded for review and evaluation by USACDC in accordance with paragraph 6f, AR 1-19 and by USCONARC in accordance with paragraph 6c and d, AR 1-19. Evaluations and corrective actions should be reported to ACSFOR OT within 90 days of receipt of covering letter.

2. Information contained in this report is provided to insure appropriate benefits in the future from Lessons Learned during current operations, and may be adapted for use in developing training material.

BY ORDER OF THE SECRETARY OF THE ARMY:

Kenneth G. Wickham
KENNETH G. WICKHAM
Major General, USA
The Adjutant General
FEB 23 1968

1 Incl
as

DISTRIBUTION:

- Commanding Generals
 - US Continental Army Command
 - US Army Combat Developments Command
- Commandants
 - US Army Command and General Staff College
 - US Army War College
 - US Army Air Defense School
 - US Army Armor School
 - US Army Artillery and Missile School
 - US Army Aviation School
 - US Army Chemical School
 - US Army Civil Affairs School
 - US Army Engineer School
 - US Army Infantry School
 - US Army Intelligence School
 - US Army Adjutant General School
 - US Army Missile and Munitions School
 - US Army Southeastern Signal School

REGRADED UNCLASSIFIED
WHEN SEPARATED FROM
CLASSIFIED INCLOSURES

CONFIDENTIAL

CONFIDENTIAL

2

DISTRIBUTION (Cont'd)

US Army Medical Field Service School
US Army Military Police School
US Army Ordnance School
US Army Quartermaster School
US Army Security Agency School
US Army Signal School
US Army Special Warfare School
US Army Transportation School

Copies Furnished:

Office, Chief of Staff, US Army
Deputy Chiefs of Staff
Chief of Research and Development
Assistant Chiefs of Staff
Chief of Engineers
The Surgeon General
The Provost Marshal General
Research Analysis Corporation (Library)
Dr. Martin J. Bailey, OSD (SA)
National Aeronautics and Space Administration, Office of Defense Affairs
Director, Weapons System Evaluation Group
Defense Documentation Center
CG, US Army Weapons Command
CO, 3d Brigade, 25th Infantry Division

This report received at Hqs, Department of the Army without indorsements. To preclude further delay in benefits gained from the lessons learned, herein, this report is published without complete indorsements.

2

CONFIDENTIAL

CONFIDENTIAL

HEADQUARTERS, 3D BRIGADE TASK FORCE
25th Infantry Division
APO San Francisco 96355

AVDC-O-OP

10 August 1967

SUBJECT: Operational Report for Quarterly Period Ending 31 July 1967
(RCS-CBFCR-65) (U).

TO: See Distribution

SECTION I (C) SIGNIFICANT ORGANIZATION ACTIVITIES

1. (C) **GENERAL:** During the reporting period 1 May to 31 July 1967, the 3d Brigade TF, 25th Infantry Division participated in Operation Baker for a total of 92 consecutive days in combat. The 3d Brigade TF, 25th Infantry Division has participated in 448 days of consecutive days in combat as of 31 July 1967.

a. **Mission:** The Brigade mission in Operation Baker was to assume responsibility within the DUC PHO TAOR, for:

- (1) Offensive and defensive operations designed to locate and destroy NVA, Main Force, Local Force, and Guerrilla units as well as Viet Cong Infrastructure.
- (2) Support of Revolutionary Development.
- (3) Counter infiltration operations in the coastal areas within the TAOR.
- (4) Conduct of psychological operations in support of tactical operations and revolutionary development.
- (5) Conduct of offensive and reconnaissance operations within the TAOR, coordinating as appropriate with CG 2d ARVN Division.
- (6) Conduct of offensive operations outside of DUC PHO TAOR, as directed or approved by CG TASK FORCE OREGON.
- (7) Participating in the defense of other US and GVN critical installations as directed by CG TASK FORCE OREGON.
- (8) As directed by CG TASK FORCE OREGON and in coordination with appropriate GVN Provincial and District Authorities, assist in the training of and render support to GVN Regional and Popular Forces.

FOR OT RD File
670701

CONFIDENTIAL

*Downgraded at 8 year intervals
Declassified after 12 years
DOD DIR 5200.10*

18 August 1967

SUBJECT: Operational Report for Quarterly Period Ending 31 July 1967
(ROS-CSFOR-65) (U)

(9) Be prepared on a quick reaction basis when directed by CG TASK FORCE OREGON to relieve and/or reinforce CIDG Camps at BA TO (BS558327), GIA VUC (BS379270), TRA BONG (BS345882), HA THANH (BS386704), MINH LONG (BS541525), and KHAM DUC (ZC005080). 3D Brigade TF, 25th Infantry Division has primary responsibility for BA TO and GIA VUC; secondary responsibility for the latter four camps.

(10) Be prepared on 12 hours notice to provide one reinforced infantry battalion for employment anywhere in South Vietnam. Be prepared on an additional 12 hours notice, to deploy the remainder of the 3d Brigade TF, 25th Infantry Division anywhere in South Vietnam.

b. Operational area (See inclosure 1): The area designated for Operation Baker encompasses the majority of DUC PHO and parts of MO DUC Districts, Quang Ngai Province, covering an area of approximately 155 square miles.

c. Control: The 3d Brigade TF, 25th Infantry Division was under the operational control of TASK FORCE OREGON throughout the reporting period.

d. Task Organization: Principal units of the 3d Brigade TF, 25th Infantry Division, with commanders' names and dates of command and the major supporting and operational control units are as follows:

Headquarters, 3d Brigade TF, 25th Infantry Division
Colonel James G. Shanahan (1 May - 24 June 1967)
Colonel George E. Wear (24 June - 31 July 1967)

Deputy Commander 3d Brigade TF, 25th Infantry Division
LTC Rodney B. Gilbertson (1 May - 22 June 1967)
LTC John D. Weil (22 June - 31 July 1967)

1st Battalion, 11th Infantry
LTC William H. Miller (1 May - 21 July 1967)
LTC Peter P. Petro (21 July - 31 July 1967)

1st Battalion, 35th Infantry
MAJ James E. Moore

2nd Battalion, 35th Infantry
LTC Clinton E. Granger (1 May - 14 June 1967)
LTC Norman L. Tiller Sr. (14 June - 31 July 1967)

2nd Battalion, 9th Artillery
LTC Bruce Holbrook (1 May - 18 June 1967)
LTC Gerald B. Bobzien (19 June - 31 July 1967)

SUBJECT: Operational Report for Quarterly Period Ending 31 July 1967
(RCS-CSFOR-65) (U)

C Troop, 3d Squadron, 4th Cavalry
CPT John P. Irving III (1 May - 9 May 1967)
CPT Ronald Penn (9 May - 28 May 1967)
1LT Richard A. Knudson (28 May - 31 July 1967)

3d Support Battalion (PROV)
MAJ Robert K. Rutledge.

Company D, 65th Engineer Battalion
CPT Arthur J. Pansse Jr.

40th Infantry Platoon (Scout Dog)
1LT Robert W. Thackeray

174th Aviation Company (OS) (1 May - 31 July 1967)

C Co, 2nd 34th Armor (attached) (1 May - 31 July 1967)

B Troop, 1st Squadron, 9th Cavalry (OPCON) (1 May - 28 June 1967)

Principal Staff:

S1
MAJ John D. Weil (1 May - 15 June 1967)
MAJ Henri M. Weinberg (15 June - 31 July 1967)

S2
MAJ Edgar Egeland

S3
MAJ Emil P. Houben

S4
MAJ John A. Joyce

S5
MAJ John W. Schnieder Jr. (1 May - 17 June 1967)
CPT Converse B. Smith (17 June - 31 July 1967)

2. INTELLIGENCE:

a. Situation Prior to Deployment - DUC PHO and MO DUC had been under the domination of ultra Nationalistic Communists since the end of WW II. These two districts had provided the communists with a regular food source, a secure area for resupply operations, important operational bases and many well indoctrinated communist leaders. Volumes of evidence indicate that every phase of daily life was organized to provide complete

SUBJECT: Operational Report for Quarterly Period Ending 31 July 1967
(RCS-CSFOR-65) (U)

control over all of the people. Active in the area were Communist youth organizations, fisherman's associations, woman's associations, farmer's associations, a teacher's federation, a merchant's association, a Buddhist association, and others. An extensive communist school and dispensary system had been organized. The control of the people was so thorough that the first three months of American Marine operations in the area convinced only three enemy to rally to the GVN. Government authorities in DUC PHO District estimated that 80% of the 90,000 people of DUC PHO were communists or communist sympathizers. Regular enemy forces in the vicinity included three battalions of the second VC Regiment, totaling close to 2000 men, 3 battalions of the 22d NVA Regiment with a composite strength of 1400 men, the 60th Battalion of the 1st VC Regiment with 300 men, the 300th Heavy Weapons Battalion of the 3d NVA Division with 300 men, and several companies of local forces totaling about 300 men. These forces were augmented by armed guerrillas in the villages and hamlets and were materially aided by the extensive infrastructure of the local Communist Government.

b. The First Phase - 19 April - 1 June: The 3d Brigade TF, 25th Infantry Division, fought a new type of battle upon deployment of troops in the lowlands of DUC PHO and MO DUC. Regular enemy troops were entrenched in fortified hamlets and were fighting with the local village and hamlet guerrillas. It was evident that the enemy had carefully considered all of the approaches to the fortified villages and had constructed mutually supporting bunkers with interconnecting trenches and concealed escape routes. The enemy fought well, adjusting his forces to counter US attacks, exercising strict fire discipline and making maximum use of cover and concealment. The Brigade successfully countered these tactics and defeated the enemy in a series of fierce battles by utilizing helicopter assaults to surround a fortified village and then employing artillery and air strikes to destroy the enemy in his fortifications. During this period instances of ground to air fire and anti personnel and anti tank mining increased as a reaction to US Forces opening roads and conducting extensive search and destroy operations. The ground to air fire was preplanned and effective, however the enemy soon learned that if he fired at an aircraft US response was always immediate and violent. The mining incidents revealed that the enemy had several well trained sapper teams who were clever and imaginative in the use of local materials to fabricate their devices. Effective sources of tactical intelligence consisted of the inherent reconnaissance in force characteristic of search and destroy operations, aerial reconnaissance from patrolling helicopters and fixed wing aircraft, and agent reports from the District Operations and Intelligence Center. Each was effective, especially the DOIC agent reports which provided US Forces with extremely valuable and current information from which timely operations could be preplanned. The agent reports were not based solely upon professional low level agents. Most of the reports came from local people who had a vested interest in the Government of South Vietnam and a hatred and fear of communists.

CONFIDENTIAL

AVDC-0-0P

10 August 1967

SUBJECT: Operational Report for Quarterly Period Ending 31 July 1967
(RCS-OSFOR-45) (U)

c. The Second Phase - 2 June - 31 July: In contrast to the earlier period of Operation Baker, the pitched battles with regular enemy soldiers were fought only on the periphery of the area of operation. The enemy sought to avoid contact and concentrated his efforts on harassing friendly forces and interdicting traffic on Highway #1. During this period the number of mine and booby trap incidents continued to increase, however instances of ground to air fire against fixed wing and rotary type aircraft began to decrease. In late June and early July, evidence indicated that two and possibly three regular battalions had infiltrated into the area of operations north of the Tra Cau River. The brigade had pitched battles with three different regular force battalions in Northern MO DUC District. The operational bases for these enemy battalions were located in the vicinity of BS7052, BS7753, and BS7361, with the last the most active. Enemy activity in the southern part of DUC PHO District was reduced considerably. Several sharp contacts were made during the months of June and July, however most of the fighting consisted of methodically cleaning up small pockets of VC and NVA hiding in tunnels and hedgerows. Almost 700 VC were killed in this manner, mostly in the Northern part of the Brigade AO.

d. Summary of Enemy Personnel & Equipment Losses - 1 May - 31 July:

(1) Personnel

KIA	1,339
CIA	249
RET	224

(2) Weapons:

SA	390
CS	20

(3) Other Equipments:

(a) Ammo:

SA Ammo	13,034
81/82mm Mortar rds	312
60mm Mortar rds	1
Grenades	349
Rocket Launcher	7
TNT	199 lbs.
250 lb bomb	30

(b) Personal Equipments:

Packs	131
-------	-----

CONFIDENTIAL

CONFIDENTIAL

AVDC-O-OP

10 August 1967

SUBJECT: Operational Report for Quarterly Period Ending 31 July 1967
(ROG-OSFVR-65) (U)

Clothing Sets	25
Canteens	61
Web Gear	24
Ponchos	131

(c) Misc:

Magazines	115
Flashlights	2
Med Equipment	95 lbs
Radios	11

(d) Material Destroyed:

Hut	341
Rice	717 lbs
Bridges	0
Bunkers	1,458
Caves/tunnels	29/306
Foxholes	132
Boats/rafts	0
Salt	0
Grain	0

(e) Material Captured:

Rice	289.7 tons
Salt	21.0 tons

3. OPERATIONS AND TRAINING:

a. Plans:

(1) During Operation Baker, the 3d Brigade TF had contingency plans for the relief and reinforcement of GIIG Camps at the following locations:

(a) Primary:

1	BA TO - BS556327.
2	GIA VUC - BS377271.

(b) Secondary:

1	MINH LONG - BS535510.
2	TRA BONG - BS391704.
3	HA THANH - BS391704.

CONFIDENTIAL

AVDC-0-0P

10 August 1967

SUBJECT: Operational Report for Quarterly Period Ending 31 July 1967
(RCS-OSFOR-65) (U)

(2) 3d Brigade TF prepared a MONTEZUMA Base Defense Plan and a plan to upgrade facilities at MONTEZUMA in preparation for the approaching monsoon season.

b. Operations:

(1) General: The brigade continued with the missions assigned for Operation Baker throughout the reporting period (1 May - 31 July). The First and Second Battalions, Thirty Fifth Infantry conducted search and destroy operations in their respective area of responsibility with attachments from C Troop, 3/4 Cav and C 2/34 Armor. The contacts in May were heavy and in some cases were initiated by an enemy attack. In all cases the enemy forces were defeated and heavy casualties were inflicted. In June and July the contacts became smaller as the Brigade's operations forced the enemy forces to shift their base of operations into the hills and break up into small elements. It became more and more a process of locating and destroying small pockets of VC and NVA resistance. The concept of operations was to advance over suspected avenues of enemy movement, methodically searching for enemy personnel, caches, and fortifications. The objective was to deny the enemy use of the inhabited lowlands of DUC PHO and MD DUC Districts and thereby cut him off from his source of food, intelligence, labor, and recruits. In order to accomplish this it was necessary to have the physical presence of US troops. The general plan was to have the infantry battalions establish fire bases with the battalion command post, supporting indirect fire elements, and one rifle company and then conduct sweeps and search and destroy operations with the other rifle companies, attached cavalry, and attached armor elements. The Infantry was used to find and fix the enemy. Once this was accomplished all available fire power was brought to bear on the enemy. Then the infantry advanced, methodically searching and destroying every enemy position.

(2) 1st Battalion, 35th Infantry: During the reporting period the 1st Battalion, 35th Infantry conducted search and destroy operations in their AO with the battalion CP located at LZ OD (OLIVE IRAB) BS786368. The battalion had major contacts in fortified villages on 19 May at NGA MAN and on 22 May at DIEN TRUONG (4). In addition there were many minor contacts and ambush engagements, and one major contact in the mountains on 15 July with a reinforced NVA platoon, (See Inclosure 4).

(3) 2nd Battalion, 35th Infantry: During the reporting period the 2nd Battalion, 35th Infantry conducted search and destroy operations in their AO with the Battalion CP being located at LZ LZ, BS751136. The Battalion had three major contacts on 20 May, 21-29 May, and 21 June, (See Inclosure 5,6). A detailed explanation of the techniques employed during these operations is included in the inclosures.

CONFIDENTIAL

CONFIDENTIAL

10 August 1967

AVDC-0-OP

SUBJECT: Operational Report for Quarterly Period Ending 31 July 1967
(RCS-CSFOR-65) (U)

In between these major contacts the battalion concentrated on finding and destroying the enemy located in the many spider holes and tunnels throughout the battalion area of operations. (See Inclosure 2).

(4) 1st Battalion, 11th Infantry: During the reporting period the 1st Battalion, 11th Infantry was under the operational control of the 196th Light Infantry Brigade.

(5) Troop C, 3rd Squadron, 4th Cavalry: From 1 May 1967 to 18 July 1967, C Troop (-) was OPCON to the 2nd Battalion, 25th Infantry. During this period, the Troop conducted search and destroy operations around LZ LIZ and east to the beach area. One platoon was OPCON to B Troop, 1st Squadron, 9th Cavalry for security of LZ MONTEZUMA, with two of its APC's OPCON to the 39th Engineer Battalion, to provide security for engineer work parties along Highway #1. A provisional tank platoon was OPCON to the 1st Battalion, 35th Infantry for search and destroy operations along the beach south of LZ GUADALCANAL. From 19 June to 31 July one APC platoon was OPCON to the 2nd Battalion, 35th Infantry for search and destroy operations around LZ LIZ. The troop (-) was OPCON to the 3d Brigade for security of LZ MONTEZUMA and the road from LZ MONTEZUMA to LZ GUADALCANAL. From 3 July 1967 to 31 July 1967 one platoon was OPCON to the 1st Battalion, 35th Infantry for search and destroy operations in the Northwest corner of the battalion AO.

(6) D Company, 65th Engineer Battalion:

(a) Engineer support to the infantry battalions in the TACR averaged five (5) line squads per day and consisted mainly of:

- 1 Clearing landing zones.
- 2 Destruction of enemy caves, tunnels, bunkers, and defensive positions.
- 3 Construction, maintenance, and clearing of defensive perimeters.
- 4 Mine clearing.
- 5 Technical assistance in construction of field fortifications.
- 6 Construction of tactical bridging.

(b) Engineer support at the forward base camp (LZ MONTEZUMA) included:

- 1 Construction and maintenance of Brigade forward base.

CONFIDENTIAL

AVDC-C-OP

10 August 1967

SUBJECT: Operational Report for Quarterly Period Ending 31 July 1967
(RCS-GSFOR-65) (U)

- 2 Helipad construction and maintenance.
- 3 Maintaining a water supply point.
- 4 Peneprime distribution.
- 5 Mine clearing.
- 6 Road construction.

(c) Base Defense: D/65th Engineer Battalion assumed responsibility for the control of the IZ MONTEZUMA Base Defense upon departure of B/1/9 Cav, 1st ACD.

(7) 2nd Battalion, 9th Artillery: During the period 1 May 1967 through 31 July 1967, the mission of the 2nd Battalion, 9th Artillery was direct support of the 3d Brigade TF, 25th Infantry Division. Battery A, was in direct support of the 1st Battalion, 35th Infantry; Battery B, was in direct support of the 1st Battalion, 14th Infantry, and Battery C, was in direct support of the 2nd Battalion, 35th Infantry.

(a) During the reporting period the 2nd Battalion, 9th Artillery fired the following missions and rounds:

	<u>OBSERVED MISSIONS</u>	<u>OBSERVED ROUNDS</u>	<u>UNOBSERVED MISSIONS</u>	<u>UNOBSERVED ROUNDS</u>
	271	8626	1773	7022
	374	8841	1254	5335
	308	8123	1473	4213
	---	---	---	---
TOTAL	953	25,590	4,500	16,570

(b) In addition to the three firing batteries, one artillery battery and one search-light section were under the operational control (OPCON) of the 2nd Battalion, 9th Artillery during this period. These units functioned in an excellent manner. The firing battery fired in support of the infantry units in contact, fired checking fires, answered immediate fire requests and greatly enhanced our extensive harassment and interdiction (H&I) program. The search-light section assisted in the defense of the several fire bases in the Brigade Area of Operation (AO), and was also successfully integrated into the H&I program. These units, and the period that they were under the OPCON of the 2nd Battalion, 9th Artillery area as listed below:

CONFIDENTIAL

AVDC-C-OP

10 August 1967

SUBJECT: Operational Report for Quarterly Period Ending 31 July 1967

(RCS-CSFOR-65) (U)

12

1 Battery A, 2nd Battalion, 320th Artillery
OPCON to 2nd Battalion, 9th Artillery (3 May - 5 May 1967)

2 Five each search-lights from Battery G, 29th
Artillery, OPCON to 2nd Battalion, 9th Artillery (12 July - 31 July 1967).

(c) 2nd Battalion, 11th Artillery supported the 2nd
Battalion, 9th Artillery, in a general support - reinforcing role during
the period 1 May 1967 through 31 July 1967. This Battalion with the at-
tachment of Battery C, 3d Battalion, 18th Artillery, fired in support of
the infantry in contact, fired blocking fires, answered calls for immediate
fire, and added great depth and power to the H&I program of the brigade.

c. Aviation: During the quarterly period the Brigade Aviation
Section flew 807 hours, 2018 Sorties, and carried 1587 passengers in the
OH-23 helicopters. The UH-1B's flew 204 hours, 475 Sorties, and carried
487 passengers. The totals were: 1011 hours, 2493 Sorties, and 2074
passengers. Two of the OH-23's, armed in July to provide a scout
team, were credited with 8 VC KIA and assisted in the capture of three NVA.
Air mobile support was provided to the 3d Brigade TF by the 174th Avia-
tion Company, 14th Aviation Battalion throughout the reporting period.
174th Aviation flew 7,678 hours, 44,531 Sorties, moved 53,479 troops,
carried 3,150 tons of cargo, conducted 101 Combat Assaults, 43 extractions,
accounted for 45 VC KIA, and assisted in the capture of 2 VC.

d. Tactical Air Support statistics for the reporting period
were as follows:

	FAC Missions		Combat Proofs	
	<u>Req</u>	<u>Flown</u>	<u>Req</u>	<u>Flown</u>
MAY	191	173	146	76
JUNE	129	85	85	45
JULY	170	123	102	72
TOTAL:	490	381	333	193

e. Chemical: Riot control agent (CS) and white phosphorous
grenades were employed to the maximum extent to clear tunnels and bunkers.

f. Training: During the reporting period 3d Brigade TF person-
nel graduated from the following schools:

CONFIDENTIAL

13
AVDC-C-OP 10 August 1967
SUBJECT: Operational Report for Quarterly Period Ending 31 July 1967
(RGS-LSFOR-65) (U)

<u>SCHOOL</u>	<u># GRADUATED</u>
3d Brigade NCO Preparatory School	163
4th Division NCO School	64
MACV Recondo School	10
4th Division Pre Recondo School	7

4. LOGISTICS:

a. General: The 3d Support Battalion (PROV) had primary responsibility for logistical support to the brigade. The 1st Log Command, Task Force Gallagher, continued to provide general support to the brigade. The reactivation of a formal supply activity account with the 1st Log Command greatly improved the requisitioning and receiving procedures for Class II & IV items, including repair parts. Class II & IV and maintenance support for elements in the Pleiku Base Camp continued to be provided by the 4th Infantry Division.

b. Supply:

(1) Class I:

(a) Perishable and nonperishable items were provided by FSA under supervision of Task Force Gallagher, 1st Log Command. All distribution was made to the Brigade Class I yard for storage and issue. Ration break-down for all tenant units in LZ MONTUZUMA was accomplished by the 3d Support Battalion (PROV). Nonperishables were stored in the open on the ground. No problems were encountered with open storage due to the dry climate. Perishables were stored in (3) three 1½ ton reefer freezers.

(b) Class I Statistics:

A Rations: 570,400

C Rations: 275,700

(c) Class II & IV:

1 Depot ships direct to our activity address code through the Brigade Supply Officer, to a Class II & IV storage and distribution area. This was made possible by the opening of a supply account enabling all organic, attached and OPCON units to requisition and draw directly from the Brigade Supply Officer, rather than returning to a distant base camp.

CONFIDENTIAL

CONFIDENTIAL

AVDC-0-0P

10 August 1967

SUBJECT: Operational Report for Quarterly Period Ending 31 July 1967
(RCS-OSFOR-65) (U)

2 Initially, requisitioning procedures to depot were ill defined. However, a workable courier system was established by Task Force Gallagher which enabled prompt passage of requisitions to depots at Qui Nhon, Cam Ranh Bay, and DaNang. Long range planning and longer lead times are still required at all levels because of the longer shipping time inherent in sea movements.

3 The completion of the airstrip at DUU PHO on 15 May 1967 greatly aided the functioning of the logistical train, bringing quick delivery of personnel replacements, R&R, and necessary items of equipment.

(d) Class III:

1 Task Force Gallagher provided wholesale issue of all types of fuel.

2 PGI Statistics:

Mogas	560,000
Diesel	520,000
Avgas	110,000
JP-4	970,000

(e) Class V:

1 Task Force Gallagher operated the local ASP and was in turn supported from Qui Nhon. Original stockage levels for the ASP did not always meet the demands of the supported units, however they were easily readjusted.

2 Class V Statistics:

81HE	26,102
4.2HE	12,568
105HE	27,356

c. Transportation:

(1) Two (2) light truck squads and one (1) medium truck squad from the 3d Support Battalion supported the brigade units at LZ MONTENAPAL. The cargo capabilities of the 5 ton bridge trucks, organic to a platoon of the 554th Engineer Company (Float Bridge) has also been used.

10 August 1967

SUBJECT: Operational Report for Quarterly Period Ending 31 July 1967
(RCS-CSFOR-65)

(2) Air Force C-123 and C-7A aircraft provided a scheduled air lift between the brigade at DUC PHO and its rear detachments at Pleiku. Averaging four sorties per day, the aircraft compiled the following record during the reporting period:

(a) Sorties: 464
(b) Passengers: 9,855
(c) Cargo: 289 tons

d. Medical:

(1) Number of patients admitted: 1,695
(2) Number of disease cases: 1,006
(3) Number of battle casualties: 232
(4) Number of non-battle casualties: 457

5. CIVIL AFFAIRS:

a. General: Priority of effort was directed towards the following three areas: public health and sanitation, public education, and refugee relief. All projects were designed to be short range and high impact in nature. All projects were requested by GVN officials and work was performed by indigenous labor. US personnel and units participating in civic action in DUC PHO were: S5, 3d Brigade TF, 25th Infantry Division, a team from 1st Civil Affairs Company, a team from 29th Civil Affairs Company and the MACV Sector Advisory Team. GVN Agencies included four RDC Teams, Refugee Relief Personnel, VIS, and the VN Cultural Drama Team.

b. Medoap Results:

(1) Sickcall 20,953
(2) Dental 78
(3) Baths for Children 1,257

c. Engineer Projects:

(1) Schools: A new five room high school was 90% completed during the reporting period. A new five room elementary school was 50% completed, and a library/class room was finished at the first evangelical

CONFIDENTIAL

AVDC-G-OP

10 August 1967

SUBJECT: Operational Report for Quarterly Period Ending 31 July 1967
(RCS-CSFOR-65) (U)

16

Church Refugee Camp. Repairs were completed on three additional schools with a total of 16 class rooms being renovated.

(2) Wells: Three new wells were completed, with eight more presently under construction. Six wells were reclaimed and repaired.

(3) Latrines: Three new latrines are under construction.

(4) Orphanage: A new dining room is under construction at the DUC PHO Orphanage.

(5) Hospital: Repairs were begun to upgrade and improve the facilities at the DUC PHO Hospital.

(6) Dams: One dam was constructed to provide water for the Hoa Thanh Refugee Camp.

d. Commerce: 47 local laborers were hired daily to fill sandbags at 70 Piasters per day. As of 24 July 1967, 350 local laborers were being hired daily to gather rock at 70 Piasters per day. A total of 350 cubic meters of rock were obtained.

e. Refugee Assistance:

(1) 8000 refugees were generated from military operations in the 3d Brigade AO.

(2) 800 refugee housing units were constructed.

(3) The following supplies were provided:

Rice	285 tons
Salt	23 tons
Clothing	1,500 lbs
Tobacco	508 boxes
Candy	1003 boxes
Soap	6690 bars
Foodstuffs	25 tons
#10 cans	1000 ea

CONFIDENTIAL

17

AVDC-G-OP

CONFIDENTIAL

10 August 1967

SUBJECT: Operational Report for Quarterly Period Ending 31 July 1967

f. Other:

(1) English Classes; Four hours were given daily with an average attendance of 30 pupils per class.

(2) Audio/Visual Programs: Movies were shown three times a week in the DUC PHO Market place. Films were provided by the military and equipment and operators were provided by the Vietnamese Information Service.

g. Psywar:

(1) Psyops activities during the reporting period included leaflet drops, and aerial and ground speaker missions, (both tape and live). The primary effort was in support of tactical units with the secondary effort directed towards refugees and other personnel already under GVN influence.

(2) Leaflet drops and aerial speaker missions were accomplished by C-47, U-10, O-2 and UH-1D aircraft.

(3) The use of armed propaganda personnel (ex VC specially trained in psywar) to make live broadcasts and appeals was very successful. They were best utilized on the ground after the infantry had trapped the enemy in caves and tunnels.

(4) Tapes and live appeals were directed toward specific individuals and units while exploiting Chu Hoi ralliers.

(5) Summary:

- (a) Leaflets dropped 18,279,400
- (b) Aerial speaker time 70 hrs, 30 min
- (c) Ground speaker time 337 hrs
- (d) Chieu Hoi Ralliers 257
- (e) Weapons 17
- (f) Leaflets fabricated 11
- (g) Tapes made 28

6. PERSONNEL:

a. Unit Strength:

CONFIDENTIAL

AVDO-O-OP

SUBJECT: Operational Report for Quarterly Period Ending 31 July 1967
 (ROS-CSFOR-85) (U)

10 August 1967

(1) As of 31 July 1967, the strengths of the units of the 3d Brigade TF, 25th Infantry Division were as follows:

	<u>AUTH</u>			<u>ASG & ATTACH</u>			<u>PIV</u>		
	OFF	WO	EM	OFF	WO	EM	OFF	WO	EM
HHC Dda	27	7	217	40	5	379	37	5	303
1/14	37	2	790	32	2	770	29	2	733
1/35	37	2	790	30	1	784	30	0	741
2/35	37	2	790	28	1	750	27	1	715
2/9	39	3	452	36	4	432	35	4	405
D/65th	5	0	154	7	0	175	7	0	174
D/725th	10	2	224	10	2	228	10	2	214
B 25th Med	10	0	85	7	0	70	6	0	66
C 3/4 Cav	5	0	172	5	0	181	3	0	170
40th SD	1	0	26	1	0	30	1	0	30
14th PIO	2	0	3	1	0	5	1	0	5
TOTAL	210	18	3703	197	15	3804	186	14	3556

(2) The 3d Brigade, 25th Infantry Division Strength Fluctuated Daily during this period. The following are Periodic Strength Figures:

ASSIGNED

DATE	OFF	WO	EM	DATE	OFF	WO	EM
5 May	220	19	3784	5 May	209	17	3644
12 May	206	19	3735	12 May	194	17	3600
19 May	212	18	3732	19 May	203	16	3562
26 May	208	17	3870	26 May	201	16	3693
31 May	198	17	3847	31 May	191	16	3703
5 June	194	17	3937	5 June	183	17	3781
12 June	197	17	3964	12 June	185	17	3797
19 June	208	18	3912	19 June	197	18	3767
26 June	203	18	3882	26 June	193	17	3644
30 June	203	17	3863	30 June	190	16	3577
2 July	198	15	3817	2 July	191	14	3595
12 July	196	13	3863	12 July	188	12	3605
20 July	196	15	3812	20 July	182	13	3573
26 July	193	15	3799	26 July	182	14	3559
31 July	197	15	3804	31 July	184	14	3556

19

AVDC-O-OP

CONFIDENTIAL

10 August 1967

SUBJECT: Operational Report for Quarterly Period Ending 31 July 1967
(ROS-CSF-1-65) (U)

(3) Total figures on replacements received for the period
May, June, July 1967:

	E-8	E-7	E-6	E-5	E-4	E-3	TOTAL
1/14	1	1	4	1	10	260	277
1/35	1	0	15	6	10	266	298
HHC	2	0	1	3	5	5	16
2/35	0	3	1	7	12	282	308
2/4 Cav	0	1	5	8	7	43	64
SPT	0	1	0	2	3	29	35
D/65th	0	0	3	6	12	30	51
2/9	0	0	2	1	12	49	64
	<u>4</u>	<u>5</u>	<u>34</u>	<u>34</u>	<u>71</u>	<u>964</u>	<u>1113</u>

(4) The number of friendly Casualties for May, June, July
are as follows:

ORGANIC UNITS:	KIA	WIA	MIA	WIA DIED OF WOUNDS
	98	484	3	11

(5) Number of Emergency Leaves:

	MAY	JUNE	JULY
HHC 3d Dde	2	2	3
1/14 Inf	2	4	4
1/35 Inf	2	4	2
2/35 Inf	0	1	5
2/9 Arty	1	1	2
3/4 Cav	0	2	0
D/65th Engr	0	1	1
R/25th Med	0	0	1
40th Sot Dog Plat	0	0	0
14th PI Det	0	0	0
D/725th Maint	0	0	1
	<u>7</u>	<u>15</u>	<u>19</u>

(6) Personnel who departed for PCS and ETS

MAY	306
JUNE	125
JULY	365

CONFIDENTIAL

AVDC-C-OP

10 August 1967

SUBJECT: Operational Report for Quarterly Period Ending 31 July 1967
(ROS-OSFOR-65) (U)

be (c) Morale: Morale continues to be excellent within the command.

(1) Mail:

- (a) Number of bags received: 3,734
- (b) Number of bags dispatched: 1,544
- (c) Total money orders sold: \$888,437.44
- (d) Total stamp value sold: \$8,946.70
- (e) Dates mail was not received:

MAY 2, 19, 24

JUNE 9, 10, 14, 19, 21, 25, 26, 28, 30

JULY 5, 6, 7, 11, 15, 16, 23, 24, 31

(2) R & R:

(a) Out of country allocations were sufficient to satisfy the needs of the command and additional 3-day in-country R & R to China Beach was instituted. An 80% participation by the units has been in effect since the China Beach R & R was started on 27 June 1967.

(b) Monthly out of country allocations were as follows:

	<u>MAY</u>	<u>JUNE</u>	<u>JULY</u>
HHC 3d Bde	72	50	54
1/14 Inf	2	66	80
1/35 Inf	43	58	78
2/35 Inf	47	67	71
2/9 Arty	31	48	48
3d Spt Bn	23	10	12
3/4 Cav	8	14	19
	<u>226</u>	<u>313</u>	<u>362</u>

(c) There was a 100% use of allocations for all three months.

CONFIDENTIAL

CONFIDENTIAL

10 August 1967

AVDO-C-OP

SUBJECT: Operational Report for Quarterly Period Ending 31 July 1967
(RCS-OSFOR-65) (U)

c. Promotion Allocations:

	<u>MAY</u>						
	E-4	E-5	E-6	E-7	E-8	E-9	
1/14 Inf	85	3	1	1	0	0	
1/35 Inf	97	9	1	2	0	0	
2/35 Inf	65	7	0	2	0	0	
2/9 Arty	0	10	7	0	0	0	
65 Engr	19	2	0	0	0	0	
3/4 Cav	12	9	0	0	0	0	
HHC 3d Bde	3	0	0	1	1	0	
25th Med	11	0	0	0	0	0	
D/725 Maint	<u>19</u>	<u>2</u>	<u>1</u>	<u>0</u>	<u>0</u>	<u>0</u>	
TOTAL	324	42	13	6	1	0	376

	<u>JUNE</u>						
	E-4	E-5	E-6	E-7	E-8	E-9	
1/14 Inf	93	56	10	3	0	0	
1/35 Inf	92	34	8	1	0	0	
2/35 Inf	100	10	1	2	0	0	
2/9 Arty	10	20	7	1	0	0	
65 Engr	3	8	0	0	0	0	
3/4 Cav	28	4	0	0	0	0	
HHC 3d Bde	7	1	0	1	0	0	
25th Med	2	0	0	0	0	0	
D/725 Maint	<u>4</u>	<u>1</u>	<u>0</u>	<u>0</u>	<u>0</u>	<u>0</u>	
TOTAL	339	134	26	8	0	0	507

	<u>JULY</u>						
	E-4	E-5	E-6	E-7	E-8	E-9	
1/14 Inf	68	5	3	1	0	0	
1/35 Inf	26	0	2	1	0	0	
2/35 Inf	18	3	2	2	0	0	
2/9 Arty	0	8	0	0	0	0	
65 Engr	0	0	0	0	0	0	
3/4 Cav	0	0	0	0	0	0	
HHC 3d Bde	0	0	0	1	0	0	
25th Med	0	0	0	0	0	0	
D/725 Maint	<u>0</u>	<u>0</u>	<u>0</u>	<u>0</u>	<u>0</u>	<u>0</u>	
TOTAL	112	22	7	5	0	0	146

CONFIDENTIAL

AVDC-O-OP

10 August 1967

SUBJECT: Operational Report for Quarterly Period Ending 31 July 1967

22

d. The increase of promotions for the months May and June was due to a USARV msg relaxing the limitations on 2nd in-country promotions.

(1) Effective 8 July 1967 awards were being submitted to the different headquarters. All posthumous awards were being submitted to the 4th Infantry Division, while all other awards were submitted to Task Force Oregon.

(2) Awards Presented:

	<u>MAY</u>	<u>JUNE</u>	<u>JULY</u>
Air Medal	4	0	28
Army Commendation	2	6	31
Bronze Star Medal	25	22	27
Distinguished Flying Medal	1	0	0
Legion of Merit	0	0	3
Silver Star Medal	6	9	6
Distinguished Service Medal	0	0	0
Distinguished Service Cross	0	0	0
Soldiers Medal	2	0	1

e. Religion:

(1) Chaplains continued to conduct numerous religious services in the field and have noticed a significant increase in attendance.

(2) On their weekly trips to Qui Nhon the chaplains have noticed the excellent esprit of the men of the Third Brigade in the hospitals.

f. Reenlistment:

	<u>MAY</u>		<u>JUNE</u>		<u>JULY</u>		<u>PERCENT</u>
	elig-reen		elig-reen		elig-reen		
Last Prior Service RA (career)	5	5	7	7	4	4	100%
Last Prior Service (1st Term)	5	5	7	7	6	2	78%
Last Prior Service (AUS)	6	2	8	8	5	1	58%
	16	12	22	22	15	7	77%

SECTION 2 (C) COMMANDERS OBSERVATIONS AND RECOMMENDATIONS

Part I, Observations (Lessons Learned)

1. (C) PERSONNEL:

a. Item: Critical shortage of non-commissioned officers, MOS 11B40

CONFIDENTIAL

AVDO-C-OP

10 August 1967

SUBJECT: Operational Report for Quarterly Period Ending 31 July 1967
(RCS-CSFOR-65) (U)

23

Discussion: At the end of the reporting period, 31 July, a shortage of infantry non-commissioned officers, MOS 11B10, existed as follows:

E-7		E-6		E-5	
AUTH	ASG	AUTH	ASG	AUTH	ASG
27	23	114	67	189	96

Observation: Although a liberal promotion policy is a possible solution, it is not a desirable substitute for experienced and mature non-commissioned officers.

2. (C) OPERATIONS:

a. Item: Use of the collimator with the M-2A2 105mm howitzer

Discussion: The collimator can be used with excellent results in the shifting and laying of a firing battery. After being layed initially, and the collimator set, the howitzer can be layed to 0 mls by pushing the howitzer forward or backward to obtain the proper sight picture on the collimator. After laying the collimator the battery refers to the aiming circle for a safety check. When the line of fire is parallel to the line of sight from the howitzer to the collimator, the displacement cannot be taken up by moving forward and rearward. In this particular situation, it is faster to use the aiming posts.

Observation: The collimator can be used to lay the battery in much less time than when aiming posts are used.

b. Item: Problems encountered with the collimator.

Discussion: The collimator can be knocked out of alignment with only a slight bump or a strong wind, such as derived from a helicopter.

Observation: By building a bunker around the collimator it is protected from being bumped or tipped over in a strong wind. Also it is recommended that the wires from the collimator be covered with sandbags to prevent their dislocation.

c. Item: Telephone lines to howitzers

Discussion: Telephone lines (WD-1) to the howitzers are frequently cut or shorted out by personnel making improvements in the firing positions, causing a loss of communications to the howitzers.

Observation: Instead of using a hot loop to the howitzers, lay individual lines from the howitzers to a terminal block (TM-184), in conjunction with the switch board (SB-22). If a line is out, communication is lost with only one section. As a backup, install a hot loop to all guns using a different route from the primary lines. If a line is cut, the section that has lost communications can switch to the hot loop which has a connection to the switch board (SB-22).

d. Item: Use of a hot loop in a fire mission which used only one or two howitzers.

Discussion: Many fire missions required the use of only one or two howitzers. If a loop is used all phones will ring each time a mission is called to a howitzer, causing interruption until the adjusting piece answers.

Observation: By using (SB-22), any time a fire mission is received that requires only one or two howitzers, only the pieces needed are called, thus eliminating confusion. By installing another phone on the switch board, it is possible to conduct two fire missions at once.

e. Item: Ground control and contact for FAC controlled air strikes.

Discussion: The brigade has averaged four air strikes a day for this quarterly period and in one major contact had 17 air strikes in a 24-hour period. The artillery forward observer with the ground unit nearest the target area is used as the ground contact and control. This procedure has proved highly successful and has received many favorable comments from the FAC. The FO, by the very nature of his job, must be an expert map reader and must know the location of all friendly units. The FO is also the commander's advisor for fire support. This use of the FO does not tie up the command net and it allows the Company Commander to concentrate on his primary duties.

Observation: The artillery forward observer is ideally suited and trained to be the ground contact for FAC controlled air strikes.

f. Item: The problem of VC Grenadiers.

Discussion: On several occasions VC have infiltrated a unit's location and thrown hand grenades. They are very adept at this and have caused several casualties. Their primary targets have been outposts.

Observation: Several principles have been developed that have proved successful in killing some of these VC grenadiers and avoiding

CONFIDENTIAL

AVDC-O-OP

10 August 1967

SUBJECT: Operational Report for Quarterly Period Ending 31 July 1967
(RCS-CSFOR-65) (U)

friendly casualties.

- (1) Outposts should move into position after dark.
- (2) Outposts that have been in position during the day should shift their position after dark.
- (3) An ambush position should be occupied after dark.
- (4) Claymores and trip-flares should be emplaced after dark.
- (5) Units should avoid setting up near hedgerows or ditches.
- (6) Individuals should always dig in at their night position. At a minimum a prone shelter should be dug.

g. Item: The use of the portable chemical E8 CS Dispenser.

Discussion: The units of the brigade have tested and on several occasions employed the E8 CS Dispenser. It is an excellent item of equipment to use when confronted with VC in fortified positions. Many units carry at least one with them on S&D operations. When employing the dispenser the wind conditions must be considered in the unit's scheme of maneuver in the objective area. In addition the battalions keep several on stand-by should a unit need them.

Observation: Units should consider the use of E8 CS Dispensers in their tactical operations.

h. Item: There is a need for an M-79 marking round.

Discussion: It has become almost an everyday occurrence to have gunships firing in support of ground troops. The normal procedure is to have the ground troops mark their position with smoke and then point out the target by using distance and direction or referring to terrain features. Marking rounds for the M-79 could be used to rapidly indicate the target, it would also eliminate the human error in referring to terrain features.

Observation: A standard M-79 marking round should be developed.

i. Item: M-79 CS Round

Discussion: In many instances it would greatly assist the ground troops if they could fire a CS grenade at ranges further than 25 to 30 meters. A CS round for the M-79 Grenade Launcher would allow the grenadier to place non-persistent CS gas on a target more accurately and at a much greater distance.

CONFIDENTIAL

AVDC-C-CF

10 August 1967

SUBJECT: Operational Report for Quarterly Period Ending 31 July 1967
RCS-CSFOR-65) (U)

Observation: A CS round should be developed for the M-79 grenade launcher and issued to line units as soon as possible.

j. Item: There is a need for a standard survival signal mirror.

Discussion: Several key personnel in this brigade have survival mirrors. These mirrors greatly conserve the use of smoke and do not compromise the unit's position when signaling aircraft. When used properly on a sunny day they are actually easier to spot than smoke.

Observation: The standard survival signal mirror should be made available for issue on the basis of one for each rifle squad.

k. Item: Use of booby traps against the VC.

Discussion: The enemy habitually trails US troops and scavenges the unit's camp sites. Booby traps implanted in old friendly camp sites would greatly harass the enemy. To prevent friendly troops from detonating their own booby traps at a later date, self-destruct devices should be employed. The ideal device would be the chemical time delay fuse.

Observation: The chemical time delay fuse should be made available on a limited basis so that self-destruction booby traps could be used against the enemy.

l. Item: Tunnel Destruction.

Discussion: Destruction of tunnels and spider holes can be expedited by the construction of prefabricated charges at the rear area. The charges are delivered by helicopters ready for use. Two blocks of C-4 (5 lbs) have proved adequate to completely destroy the normal spider hole. A 30-second delay fuse is sufficient to allow personnel to escape the effects of the blast. When the hole is larger, two of the prefab charges are used. In addition to the prefab charges used for small tunnels and spider holes, two tunnel kits are maintained at the battalion trains consisting of flashlights, rope, gas mask, CS gas grenades, armored vests, and a grappling hook. These are pre-packaged and ready to be picked up by helicopter on a moments notice. These items can be delivered by the D&C when no other helicopter is available.

Observation: A five pound pre-fabricated charge is a great time saver for the line units in destroying spider holes. Having a tunnel kit such as the one described above ready to be brought forward on call will also save valuable time for the infantry unit.

m. Item: 106mm Recoilless Rifle.

Discussion: One of the finest weapons to be added to the infantry arsenal is the 106mm Recoilless Rifle Beehive round. The round has

CONFIDENTIAL

CONFIDENTIAL

AVDC-C*OP

10 August 1967

SUBJECT: Operational Report for Quarterly Period Ending 31 July 1967
(RCS-CSFCR-65) (U)

a simple but effective fuse allowing the firer to select muzzle action or a bursting point up to 3200 meters. A test was conducted at a range of approximately 300 meters using 25 ammunition boxes spaced over a linear distance of 50 feet and placed in depth 25 feet. Not a single box escaped the strike of at least one flosheet. Several boxes were hit as many as ten times. This round will be extremely effective against groups of personnel at various ranges. In addition to the anti-personnel round, the standard 106mm HEP round has a good casualty producing effect when employed against personnel. Due to the accuracy of the weapon system, it has successfully been employed in many roles during the reporting period. The flat coastal plain interrupted by small hill masses, in which we have been operating, offers numerous opportunities for effective employment of the 106mm Recoilless Rifle, both offensively and Defensively.

Observation: The 106mm Recoilless Rifle should be maintained at battalion level for use as an offensive and defensive weapon against personnel.

n. Item: Use of Detonation Cord in Bunker Destruction

Discussion: Destruction of bunkers is often a slow and tedious job requiring large amounts of explosives. Frequently a great deal of time is wasted by destroying one bunker then proceeding onto the next. A time saver is detonation cord laid between bunkers for hundreds of feet to destroy several bunkers simultaneously. Normal demolition procedures are used with a line of detonation cord forming the ring main of main line of the charge. Individual bunker charges are placed on the various branches. The charge is double primed and detonates almost instantly due to the high detonation rate of the cord.

Observation: The employment of large amounts of detonation cord in bunker destruction is justified by the time it saves in placement of individual charges.

o. Item: Timing of aerial resupply operations.

Discussion: Units normally develop patterns in resupply operations which will have an impact on tactical operations. The practice of conducting aerial resupply at a night defensive perimeter location pinpoints the actual location to the enemy, denies the friendly unit the advantage of surprise in establishing the defense, and increases the vulnerability of helicopters by establishing fixed patterns of activity which are predictable to the enemy.

Observation: Resupply of tactical units, at other than specific locations dictated by a tactical requirement, should be accomplished

CONFIDENTIAL

AVDC-0-OP

10 August 1967

SUBJECT: Operational Report for Quarterly Period Ending 31 July 1967
(RCS-CSEFOR-65) (U)

on an irregular basis, varying the patterns in a random manner. A unit should displace, even if only a short distance after accepting resupply.

p. Item: Ground Air Signal Strobe Light

Discussion: A battery powered high intensity strobe light, which emits a brilliant flash of light at approximately one second intervals is provided in aircraft crew emergency items for signaling. The light is visible even during daylight and is clearly visible at night over distances up to four to five kilometers. The light is provided with a shield, so that it may be employed as a directional signaling device. The entire device is about the size of a first aid packet. When used at night, the strobe light provides a light weight, compact means of identifying landing zones or drop zones to aircraft.

Observation: Each tactical unit which may be required to operate separately, (squad, IRRP, Special detachment) should be equipped with one ground to air emergency strobe light for signaling. Resupply of batteries should be maintained in the supply system.

q. Item: Depth for commitment of blocking forces.

Discussion: Experience in actions conducted in the DUC PHO area indicate that the enemy can withdraw very quickly when he believes he is faced with a superior force. Efforts to position a blocking force will hinge on the time that the force is introduced in relation to the time that the force is introduced in relation to the time when the enemy recognized the requirement for withdrawal. As a general rule, when the axis of withdrawal can be accurately predicted, the blocking force should be introduced between 1500 and 2500 meters from the point of contact. Introduction at a point closer to the point of contact may permit some enemy to escape, and may limit the use of supporting fires between the attacking and the blocking forces.

Observation: Blocking forces should be introduced as far (up to 2600 meters) from the point of contact as it may be practical to predict the enemy withdrawal routes.

r. Item: Enemy sniper employment.

Discussion: During the period covered by this report the enemy has made good use of snipers located in positions to cover booby traps placed on likely approaches.

Observation: A unit coming under sniper fire should immediately obtain maximum dispersion and establish a base of fire. The sniper or snipers should then be attacked by fire and movement using

CONFIDENTIAL

AVDC-C-OP

10 August 1967

SUBJECT: Operational Report for Quarterly Period Ending 31 July 1967
(RCS-CSTOR-65) (U)

fire teams with artillery being placed on likely sniper locations, routes of egress, and the flanks of the advancing elements.

s. Item: Enemy anti-helicopter tactics.

Discussion: US units are almost entirely dependent upon the helicopter for resupply, therefore the volume of helicopter traffic in enemy infested areas is quite heavy. Numerous documents captured by this organization have contained extensive training material on techniques for shooting down helicopters with small arms. The enemy will watch as the helicopter goes into a US position and will move to a good firing position along the final approach to the LZ. He will then select a position that will give him a good shot when the helicopter is on its final approach and is most vulnerable to ground fire. The enemy position is often several hundred meters from the LZ making counter fire by small arms difficult. The helicopter usually delivers its resupply to units during the afternoon hours and returns to pick up empty marmite containers before sundown.

Observation: The enemy tactics mentioned above can be effectively countered by saturating the approach to the LZ with fire team size patrols. This technique effectively interdicts enemy movement and provides a quick reaction force when the enemy fires on the approaching helicopter.

t. Item: The enemy's use of automatic weapons and small camp fires to deceive US troops.

Discussion: The enemy is often aware of the general night location of US units. A tactic he has employed is to fire several automatic weapons burst a safe distance from US position and build camp fires. This will usually result in artillery fire being called into the area and a subsequent search by friendly troops at first light. The enemy will then employ booby traps and snipers along the most likely route that a unit will travel when leaving the bivouac site and will patiently wait until morning when friendly troops move out on daily operations.

Observation: This tactic can be effectively countered by the following:

- (1) Avoid trails and open areas when leaving the bivouac sites.
- (2) Be especially alert during all movement.
- (3) Move from the bivouac site in a direction away from the objective area and then circle around.

30

CONFIDENTIAL

AVDO-C-OP

10 August 1967

SUBJECT: Operational Report for Quarterly Period Ending 31 July 1967
(ROS-CSFOR-65) (U)

(4) Recon by fire with organic and indirect fire weapons prior to and during movement.

(5) Conduct all movement using the tactical formations which afford the best all around security.

u. Item: Enemy Anti-Tank Mines.

Discussion: The armored units of the brigade have encountered many pressure type anti-tank mines. These mines have been placed almost exclusively along old tank trails, old ditch crossings, and other channelled areas. These mines are normally placed in such a manner that when a tank follows an old tank track the mine will detonate directly under the tank, sending the full blast under the hull and resulting in maximum damage to the hull and suspension system.

Observation: Old tank trails, ditch crossings, and other channelled areas should be avoided by armored vehicles to the maximum extent possible. When one of these danger areas must be negotiated, the area should first be checked out by probing with bayonets or checking with a mine detector.

v. Item: Enemy Recoilless Rifles and RPG-2's.

Discussion: The use of recoilless rifles and RPG-2's in the AO give Viet Cong and NVA units an effective anti tank capability. Since tanks must move relatively slow because of the terrain and the infantry with whom they operate, the danger to the tank is increased. A well concealed anti-tank team is able to detect and attack a tank well before the tanks are aware of their position. With the many ditches and hedgerows in the area, the enemy is offered many ideally concealed ambush locations and escape routes.

Observation: The best means of securing tanks against this type of attack is by employing infantry extensively along the flanks and rear of the armor. When this is done, the tanks are able to concentrate their fire power to the front, and the infantry can check along ditches and hedgerows for enemy positions along the flanks and to the rear.

w. Item: Tank Reaction Time.

Discussion: When attacks are made upon friendly units reinforced with tanks at their night locations, the key to the defense is the reaction time of the tankers to return fire. Experience has shown that as soon as hostile fire is returned effectively by tanks, the enemy will break contact.

Observation: To keep a tanks reaction time as short as

CONFIDENTIAL

CONFIDENTIAL

AVDO-C-OP

10 August 1967

SUBJECT: Operational Report for Quarterly Period Ending 31 July 1967
(RCS-CSPOR-65) (U)

possible, one man should be awake and in the tank commanders cupola at all times. His mission is to stand guard and monitor the radio. If an attack comes all he needs to do is throw the main switch on the gunner's controls and he can have a round on the way seconds after the first incoming round. In addition to the man who is awake, a second man should sleep either in the bustel rack or on the back deck. This man can be inside the tank ready to act as the loader seconds after the first hostile round is received.

x. Item: XM-69 Tunnel Destruction Kit.

Discussion: The Brigade's Engineer Company has on hand the XM-69 Tunnel Destruction Kit. The kits consist primarily of an acetylene generator and an oxygen converter and is designed to be supplemented with a Mity Mite blower. The oxygen converter must be filled with liquid oxygen within 48 hours prior to use. Liquid oxygen is not readily available and the 48 hour limitation is not feasible for current operations where tunnel destruction missions are usually given on short notice. The kit may be utilized without the blower or the oxygen converter and is effective in this manner within certain limitations concerning the length, depth, width, and ventilation of the tunnel.

Observation: The XM-69 Tunnel Destruction Kit may be effectively utilized within certain limitations. Tunnels should either be analyzed by someone aware of the kits capabilities or complete data on the tunnel should be provided when requesting a team for tunnel destruction.

y. Item: Penetrants Distributer.

Discussion: The application of penetrants or similar dust palliatives is a major engineer task in Vietnam. No distribution equipment is available to combat engineer companies or battalions. All distribution must be accomplished with fabricated or improvised distributors which are cumbersome, inefficient, and in many cases ineffective. Both a large capacity truck mounted distributor (800 gal or larger) and a smaller automobile distributor are needed.

Observation: Present equipment available for dust palliative distribution is unsatisfactory. Necessary distributors should be included in the MTOE of engineer and aviation units and made available to these units.

z. Item: Materials Handling Equipment.

Discussion: Engineer operations frequently required the loading, unloading, transfer, and movement of heavy materials. Combat Engineer companies have no organic means of loading materials too heavy

CONFIDENTIAL

AVDC-O-OP

10 August 1967

SUBJECT: Operational Report for Quarterly Period Ending 31 July 1967
(RCS-GSFOR-65) (U)

with man power. This necessitates utilization of handling equipment from other support units which are also short on lifting and loading devices. A few examples of engineer work requiring large capacity lifting devices are the loading of dust palliative 50 gallon drums, and the transfer of lumber bundles, bridging, and prefabricated ~~structures~~.

Observation: Combat Engineer companies used a 5 to 10 ton wrecker or similar piece of material handling equipment.

aa. Item: OH-23 Scout Team.

Discussion: Two of the OH-23s of the Brigade Aviation section were armed in July to provide a scout capability within the Brigade. The aircraft were armed with two M-60 machineguns mounted in the doors on Bungee Cords. The cords are attached to the door frame with a wire loop and a snap link. The OH-23 has proven to be a good scout ship with good visibility, good load carrying ability, and endurance. The two observer/gunners have provided a suppressive fire capability and increased the target acquisition capability. The scout team has been most effective in screening the perimeter of combat assault areas.

Observation: The scout team increased the surveillance capability of the Brigade. Float aircraft and rapid replacement of combat losses are absolutely essential to the operation. A minimum of two teams is desirable, but not always possible with only five OH-23 aircraft assigned to the section.

ab. Item: Action to Secure Aircraft Shot Down By Hostile Fire.

Discussion: During the reporting period one OH-23 of the Brigade Aviation Section was destroyed by hostile forces after being shot down. The crew was evacuated under fire. Prior to the time forces were available to secure the aircraft, it was blown up by a large explosive charge.

Observation: Aircraft downed in the Brigade AO must be secured immediately and evacuated as soon as possible. Sapper units are prevalent and very skillful in the Brigade Area of Operations.

ac. Item: DUC PHO Air Field.

Discussion: The many day to day problems of coordinating the DUC PHO Airfield operations consume a considerable amount of the time of the Brigade Aviation Officer. Most airfields with operations of this size have an airfield operating detachment almost as large as the aviation section.

Observation: An airfield operating detachment is needed at DUC PHO Airfield.

CONFIDENTIAL

AVDC-0-0P

10 August 1967

SUBJECT: Operational Report for Quarterly Period Ending 31 July 1967
(RCS-OSFOR-65) (U)

3. INTELLIGENCE:

a. Item: Brigade Intelligence Sources.

Discussion: Tactical intelligence when operating against unsophisticated light infantry and guerrilla forces must be available at the brigade and battalion levels. In the DUC PHO Area of Operations, experience has shown that there are only four important sources of immediate tactical intelligence. These sources are aircraft reconnaissance, reconnaissance in force (i.e. S&D operations), interrogation of POW's and returnees, and the consolidation of reports from low level agents, civilians, and interrogation of POW's which have been provided to this brigade by the District Office Intelligence Center, (DOIC). Of all the sources, the latter has proved to be the most lucrative.

Observation: The DOIC project has been successful and should be further developed and extended. In addition, the attachment of a low level agent handling team to the brigade would provide the Brigade S2 with another reliable source of intelligence in addition to the Vietnamese source.

b. Item: Interpreter Assignment.

Discussion: There is a critical shortage of interpreters in the brigade. The search and destroy operations have been conducted almost exclusively at company and platoon levels. This results in daily contact with Vietnamese people without the means to communicate due to the language barrier. As a result, a great deal of immediate tactical intelligence is lost.

Observation: There is an obvious need for at least one interpreter per rifle company with additional interpreters at Battalion and Brigade level.

c. Item: Use of OI VR Aircraft:

Discussion: Through trial and error experience, this Brigade has found that OI VR Aircraft flying over lowland populated areas are best employed in direct support of friendly sweep operations. By flying overhead when a ground unit is sweeping an area the observer is frequently able to spot VC or NVA forces attempting to evade the sweeping units. The observer then calls in artillery fire and the friendly forces on the ground maneuver to block the enemy's escape.

Observation: The employment of the OI VR Aircraft in support of S&D operations is highly recommended.

CONFIDENTIAL

AVDC-C-OP

10 August 1967

SUBJECT: Operational Report for Quarterly Period Ending 31 July 1967
(RCS-CSFOR-65) (U)

4. (C) LOGISTICS:

a. Item: Insufficient power for refrigeration units.

Discussion: At present the brigade stores its Class I perishables in three 1½ ton reefer freezers. The TOE generator equipment has proved inadequate to power these refrigeration units. The feasibility of establishing an R&U central power supply is currently under study by the Brigade S4.

Observation: There is a requirement for a minimum of two LOEW generators to be made available to Brigade size units when operating a Class I distribution point.

b. Item: Lack of qualified Reefer Repairman.

Discussion: The development of the Brigade Base complex necessitated the establishment of a cold storage and freezer capability. The minimum amount of reefer items are now on hand, however, they break down under constant use. The Brigade does not have a qualified reefer mechanic to accomplish the minimum inspections necessary to determine the cause when a break down occurs. A mechanic must be called in from a distant support unit causing great delay, and the difficulty in obtaining parts creates more of a problem.

Observation: A Reefer Mechanic should be assigned to the FSA on a permanent basis.

c. Item: Availability of Float Aircraft.

Discussion: In late June the 335th Transportation Company, the DS Maintenance Support Unit for Aviation, received a number of float OH-23 Aircraft. Float aircraft have been available to the brigade aviation section to replace battle damaged aircraft immediately, while the damage is being repaired.

Observation: The availability of float aircraft greatly increases the Brigade Aviation flying rate. In addition, it reduces the variation in mission capability during periods of frequent battle damage.

d. Item: Airlift of Packs and Unit Equipment

Discussion: To decrease the load carried by the individual soldier it is frequently practical to collect individual packs, specialized equipment (starlight scopes, trip flares, anti-intrusion detection devices), and unit equipment (mortars and ammunition, recoilless rifles etc) at first light and return them to the unit's night defensive locations. This

CONFIDENTIAL

35

CONFIDENTIAL

AVDC-C-OP

10 August 1967

SUBJECT: Operational Report for Quarterly Period Ending 31 July 1967
(RCS-CSPCR-65) (U)

enhances the ground mobility of the individual, lessens fatigue, and assists in maintaining a better overall combat posture. Adoption of this technique also permits the introduction of more and heavier weapons at a planned defensive position. To expedite lifting of equipment, storage during the day, and return at night, a cargo net might be utilized whenever the situation permits.

Observation: The technique of picking up the unit's equipment in the morning and returning it at the end of the day's operations should be utilized whenever the situation permits.

e. Item: Ammunition Resupply Packets.

Discussion: After a fire fight the requirement for small arms ammunition, grenades, and similar Class V items may be reasonably predicted, based on time in contact and the size of the force employed. A "package" of all normal types of Class V items suitable for a platoon can be established, and several of these "packages" stocked at the Battalion's trains area. When a fire fight develops an immediate ammunition resupply can be made available. The "package" can be rigged for sling load, and carried under a UH-1D aircraft for touch and go delivery, thus reducing the time the aircraft may be exposed to ground fire.

Observation: "Packages" of selected class V resupply items should be prepared for sling load aircraft, and maintained at Battalion Trains area to provide an immediate Class V resupply capability.

f. Item: Stitching on Jungle Fatigues.

Discussion: Some models of Jungle Fatigues have the seam sewn on the inside to give the exterior a more finished appearance. This leaves a projecting hump of material on the inside. When the individual soldier perspires, the uniform tends to cling to him, and the interior seams rub sore spots on the skin in contact.

Observation: Tropical Fatigues with seams sewn on the inside should be eliminated from the supply system.

g. Item: Disposable Containers.

Discussion: Normal resupply of water is accomplished for companies having aerial resupply through the use of metal 5 gallon cans and hot rations are fed using insulated food containers. In both cases the empty containers must later be extracted by helicopters. In some cases the extraction may be delayed by weather or nonavailability of aircraft, thus delaying the movement of the tactical unit required to secure the landing zone.

CONFIDENTIAL

AVDO-C-OP

10 August 1967

SUBJECT: Operational Report for Quarterly Period Ending 31 July 1967
(RO9-CSFOR-65) (U)

Observation: A disposable water container and a disposable food container should be supplied to preclude the necessity for lifting out empty food and water containers.

h. Items: The M-79 Ammunition Carrying Vest.

Discussion: Several months ago this Brigade received a small amount of M-79 Ammunition Carrying Vests. This is an item of equipment that has been needed for some time. The Vests are excellent. They are light weight, durable, distribute the load, and carry sufficient ammunition. Since the arrival of these vests, no more vests have been received even though many requests have been submitted.

Observation: The M-79 Ammunition Carrying Vest is an excellent item of equipment and should be provided to units in much greater numbers.

i. Items: Special Equipment for Tunnel Exploration.

Discussion: In this area of operation the units of the brigade have encountered numerous caves and tunnels. Some of them have been elaborate and extensive. Our problem has been to secure the equipment to properly exploit the finds. There are several items of equipment that would be of great value.

- (a) Miner Lamps
- (b) Large Flashlights (6 cell)
- (c) Revolvers with silencers
- (d) Smaller light weight gas masks

Observation: The procurement of this equipment would greatly assist in tunnel search operations.

j. Items: Spray Aircraft and preventive medicine assistance for Malaria Control.

Discussion: During the reporting period the brigade has not had a spray ship available for anti malaria spraying. It appears that all the personnel and equipment of the preventative medicine program are located elsewhere.

Observation: The Malaria incident rate is higher in the DUC PHO area than in other areas in Task Force Oregon. Therefore, it seems logical that a portion of the preventative medicine program should be allotted to this area.

37

CONFIDENTIAL

AVDG-C-OP

10 August 1967

SUBJECT: Operational Report for Quarterly Period Ending 31 July 1967
(RCS-CSFOR-65) (U)

k. Item: Effect of Climate and Terrain on Parts Life

Discussion: Sandy soil in this area has increased wear on many of the critical moving parts on vehicles. In addition, movement of armored vehicles through the rice paddies and across dykes has increased the stress on torsion bars and consequently increased breakage of these items.

Observation: The effect of soil on parts increases the importance of constant attention to first echelon maintenance, to detect problems before they become serious.

5. CIVIL AFFAIRS:

a. Item: Forced Evacuation of Hamlets.

Discussion: The tactical situation occasionally dictates that entire hamlets be forcibly evacuated. If strict control is not exercised over the personnel, they will return to their homes within 48 hours.

Observation:

(1) All such moves must be closely coordinated with district officials.

(2) Living facilities should be enclosed by wire and patrolled by GVN personnel.

(3) People must be allowed to gather up their necessary personal belongings to be evacuated with them.

(4) Food, water, shelter, and medical treatment must be provided.

b.

b. Item: Control of Handouts.

Discussion: The uncontrolled distribution of items such as candy, C-Rations, and cigarettes from vehicles is both undesirable and dangerous. It has the results of making beggars out of the children and offending the adults. Additionally it increases the possibility of serious injury to a child who is blindly chasing a vehicle in hopes of getting a handout.

Observation: Units desiring to donate surplus items should coordinate with the unit S5 and make arrangements to distribute such items to needy refugees in an unobtrusive and organized manner.

CONFIDENTIAL

CONFIDENTIAL

AVDC-C-OP

10 August 1967

SUBJECT: Operational Report for Quarterly Period Ending 31 July 1967
(RCS-OSFOR-65) (U)

38

c. Items: Utilization of Psywar Ground Teams.

Discussion: The most effective use of Psywar ground speaker teams is in support of tactical operations. There are many instances in the search and destroy missions where the infantry has trapped the enemy in caves and tunnels only to incur friendly casualties while attempting to force them out. The use of speaker teams to appeal to the enemy to surrender, while not effective 100% of the time, would reduce the number of friendly casualties and increase the number of POW's and resultant intelligence.

Observation: Infantry companies should be made aware of Psywar capabilities and encouraged to request their assistance. Once requested a high priority should be allotted for airlift of the team to the contact area.

d. Items: O2 Aerial Speaker Missions.

Discussion: Interrogation of POW's and HOI CHANHS indicates that aerial broadcasts from the O2 aircraft are not understandable. This is further substantiated by statements of interpreters and GVN troops in this area. It is believed the O2 flies at altitudes too high to be heard. In addition on several occasions the FACs supporting this unit have reported that O2 pilots have contacted them in the air and requested assistance locating a target which was not indicated on their 1:25,000 maps.

Observation: Pilots should be furnished 1:50,000 maps of their target area. Flight broadcasts should be made at an altitude of 1000 feet with more emphasis on targeting a specific hamlet rather than a large area.

Part II: Recommendations

1. Personnel: None.

2. Intelligence:

a. Higher Headquarters should do everything possible to encourage the development of the DOIC program.

b. A low level agent handling team should be attached to the brigade in order to allow the brigade S2 to establish an independent low level agent net.

c. That qualified interpreters be provided to brigade sized units on the following basis:

39

CONFIDENTIAL

10 August 1967

AVDC-C-OP
SUBJECT: Operational Report for Quarterly Period Ending 31 July 1967
(ROS-CSFOR-65) (U)

- (1) Brigade headquarters: 10
 - (a) MI section: 5
 - (b) S-5: 3
 - (c) S-2: 1
 - (d) Military Police: 1
- (2) Infantry Battalions: 5
 - (a) Battalion Headquarters: 2
 - (b) Rifle Companies: 1 each
- (3) Artillery Battalions: 1

3. Operations and Logistics:

- (a) That a standard 40mm marking round be developed for standard issue for combat units.
- (b) That a strobe light be added to the MTOE of the infantry rifle squad and IRRP team.
- (c) That Penetrator distributors be added to the MTOE of engineer and aviation units.
- (d) That an Airfield Operating Detachment be provided for the DUC PHO Airfield.
- (e) That a refrigerator mechanic be assigned to the FSA.
- (f) That Jungle Fatigues with seams sewn on the inside be eliminated from the supply system.
- (g) That disposable water and food containers be developed and supplied to tactical units.
- (h) That additional M-79 ammunition carrying vests be made available in the supply system.
- (i) That spray aircraft and preventive medicine assistance for malaria control be made available to the brigade.

4. Civil Affairs: That O2 pilots on aerial speaker missions be furnished with 1:50,000 maps of their target area and instructed to make the broadcasts at an altitude of 1000 feet with more emphasis on targeting a specific hamlet rather than a large area.

CONFIDENTIAL

Colonel, Infantry
Commanding

6 Incl:

CONFIDENTIAL

40

1. ~~Area of Operations Map~~ Withdrawn, Hqs, DA
2. Mines and Booby Traps
3. Search Technique
4. Combat After Action Report for 15 July 1967, Assault of Bunker Positions.
5. Combat After Action Report for the Period 19 May-20 May 1967, the Battle of Vinh Hien
6. Combat After Action Report for the Period 27 May-30 May 1967, the Battle of Ton Phong

Distributions:

CINCUSARPAC	2
DCG, USAFV	3
CG, IFFV	2
XG, TF OREGON	2
CG, 4TH INF DIV	1
CG, 25TH INF DIV	1
CG, 1ST CAV DIV (AM)	1
CO, 1/14 INF	1
CO, 1/35 INF	1
CO, 2/35 INF	1
CO, 2/9 ARTY	1
CO, G/3/4 CAV	1
CO, D/65 ENGRS	1
CO, B/1/9 CAV	1
CO, G/2/34 ARMOR	1
CO, HHG 3/4 TF	1
CO	1
DCG	1
XO	1
S1	1
S2	1
S3	1
S4	1
S5	1

CONFIDENTIAL

4

AVDF-GC (10 August 1967) 1st Ind
SUBJECT: Operational Report for Quarterly Period Ending 31 July 1967,
(RCS-CSFOR-65)

DEPARTMENT OF THE ARMY, HEADQUARTERS AMERICAL DIVISION, APO San Francisco
96374, 24 September 1967

TO: Assistant Chief of Staff for Force Development, Department of the
Army (ACSFOR, DA), Washington D.C. 20315

1. (U) Forwarded herewith are two copies of subject report of the
3d Brigade, 4th Infantry Division.

2. (U) Reference Section II, Part I, para 3a, Subject: Brigade
Intelligence Sources. The 3d Brigade, 4th Infantry Division has a two-
man Counter Intelligence Team assigned to the brigade. The team is well
suited for accomplishment of the tasks for which the brigade is asking
support. The District Intelligence Operations Coordination Center (DIOCC)
is a MACV concept with CAS backing. The DIOCC suffers from under-staffing
which causes a loss of efficiency; however, this is not a matter for a
brigade to address.

3. (U) Reference Section II, Part II, para 3a. Latest reports from
Headquarters, Department of the Army indicate cost estimates are extremely
high for a 40mm colored smoke round; however, immediate procurement and
continued research and development should be continued, as the requirement
is critical.

4. (U) Reference Section 2, Part II, para 3b. The unit has been
advised that MTOC action is necessary.

5. (U) Reference Section 2, Part II, para 3i. An aerial spray
capability to be mounted on a UH-1D Helicopter, was procured and became
operational on 28 August 1967. Spraying operations commenced in the DUC
PHO area on 5 September 1967. Baytex larvae killing granules, for spread-
ing over stagnant waters, has been issued to Headquarters, Americal Division
and further provided to subordinate elements. Additionally, a team consist-
ing of two personnel from the 926th Preventive Medicine Detachment was
positioned at DUC PHO to assist in the malaria prevention program in that
area.

FOR THE COMMANDER:

39

6. Incl
nc

O. A. GERNER JR.
CPT, AGC
Asst. Adj. Gen.

CONFIDENTIAL

HEADQUARTERS, 3D BRIGADE TASK FORCE
25th Infantry Division
APO San Francisco 96355

5 August 1967

SUBJECT: Mines and Booby Traps

1. The 3d Brigade Task Force, 25th Infantry Division has encountered almost every type of enemy soldier present in Vietnam; from a hamlet guard in Duc Pho District, Quang Ngai Province, to an NVA officer in the highlands of Kontum. Probably the least recognized and most dangerous enemy is the farm hand by day who has been trained to cleverly place a mine or booby trap designed to kill or maim South Vietnamese Civilians and Allied soldiers.

2. This paper has been prepared from the reports and experience of the direct support EOD Team from the 184th Ordnance Battalion.

3. Unless each individual is aware of the threat, the "Silent Soldier" will exact a high price in friendly lives.

4. General: There are and have been readily discernible patterns in the enemy's method of employment of mines. They are as follows:

a. Where?

(1) Location - Simply put, mines and booby traps will be placed where common sense says they will do the most damage. For example, a mine designed to destroy an armored personnel carrier would have the best chance for success placed at an obstacle such as a stream where an armored vehicle had previously passed. Enemy intelligence is continuously looking for patterns to friendly movements.

(2) Marking - In some instances, the enemy have marked danger areas with symbols known to the local inhabitants. There are no indications that there is any universal system of marking and, in most instances, the people of the hamlet or village are ordered by the VC leaders to stay out of a certain area without any reason given.

b. When? - Friendly forces can expect an increase in booby-trap and mining incidents as the enemy regular forces are defeated and driven away. Any time a friendly land location is established and regularly used, the enemy loses face. The enemy then tries to prove his fighting ability to the people by employing mines, booby traps, and ambushes.

c. Who? - Sappers and their trained intelligence gatherers must locate their base close enough to the target to provide quick access to and constant surveillance over the target area. The intelligence gatherer may be an old woman living along the road or children selling soda. If at all possible, the Sapper who is to set the mine will personally observe the target.

Inclosure 2

40
CONFIDENTIAL

CONFIDENTIAL

44

d. How? - The enemy intelligence gatherers are looking for only one thing-patterns of friendly action. For example, on a certain stretch of unimproved road most big trucks (U.S. Army Trucks) heading north must ease onto the road shoulder to pass. Therefore, A 30 - 40 lb explosive pressure device placed in the shoulder would surely destroy a large vehicle. Other patterns of our actions have been exploited by the enemy.

5. The enclosed line drawings are of mines and booby traps discovered by the 3d Brigade, 25th Infantry Division and the 39th Engineer Battalion.

41

CONFIDENTIAL

43-

SIMPLE PRESSURE BAMBOO TRIGGER

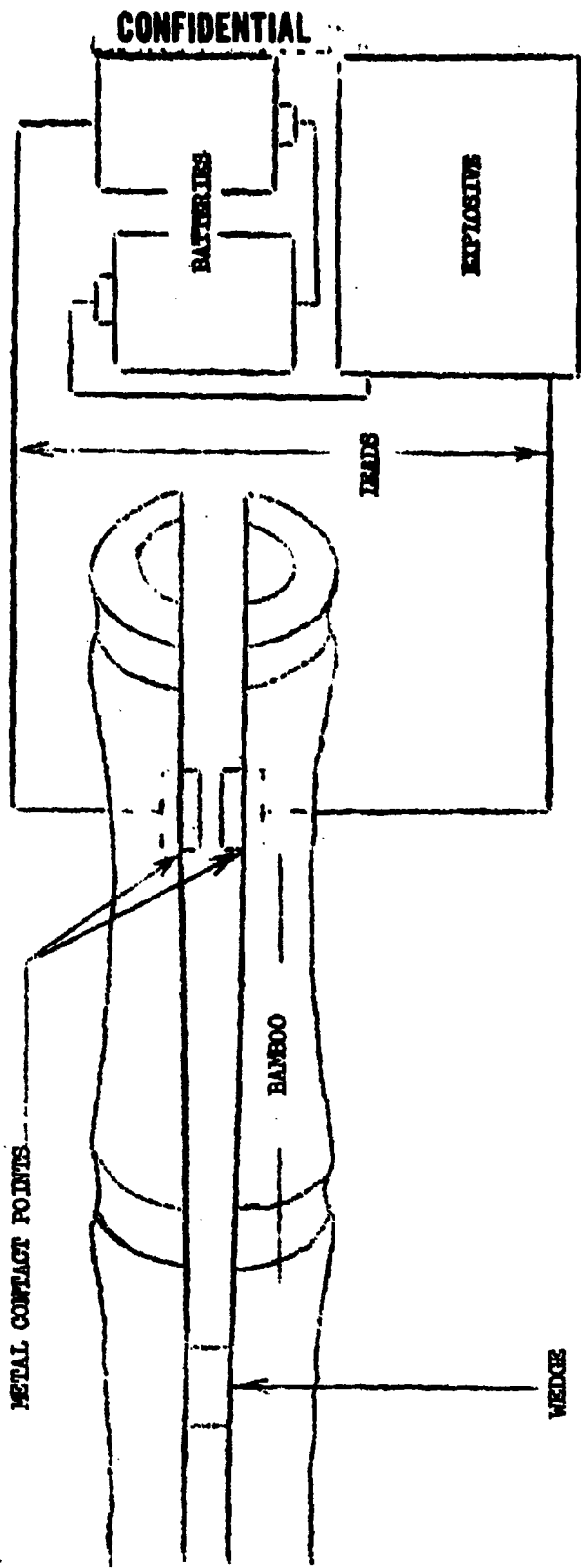

42

CONFIDENTIAL

CONFIDENTIAL

pk

BAMBOO VIBRATION TRIGGER

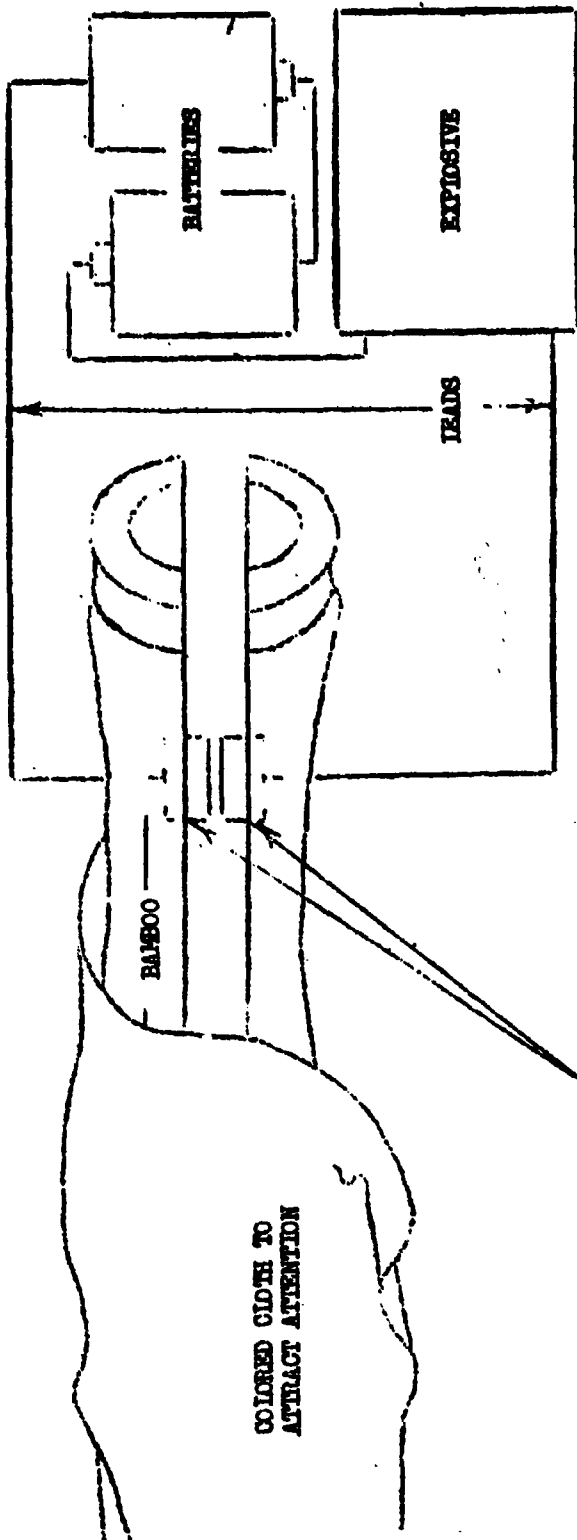

**COLORED CLOTH TO
ATTRACT ATTENTION**

METAL CONTACT POINTS

43

CONFIDENTIAL

47

BAMBOO TRIP WIRE DEVICE

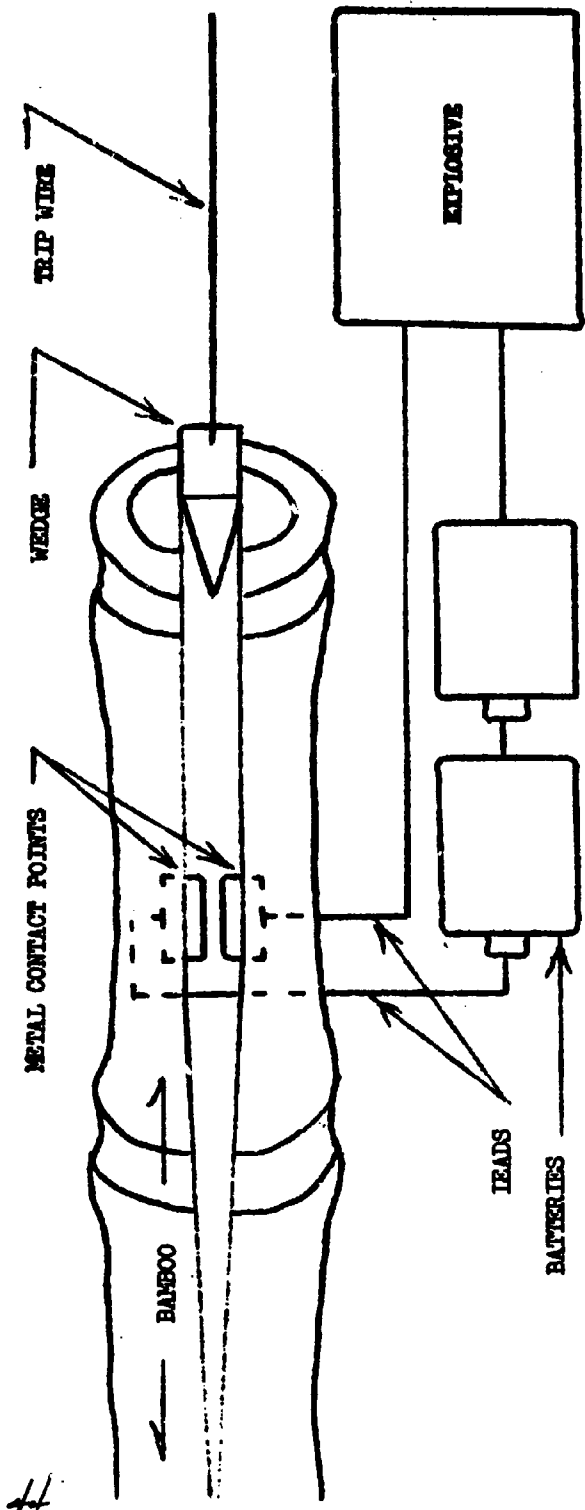

CONFIDENTIAL

CONFIDENTIAL

#

CONFIDENTIAL

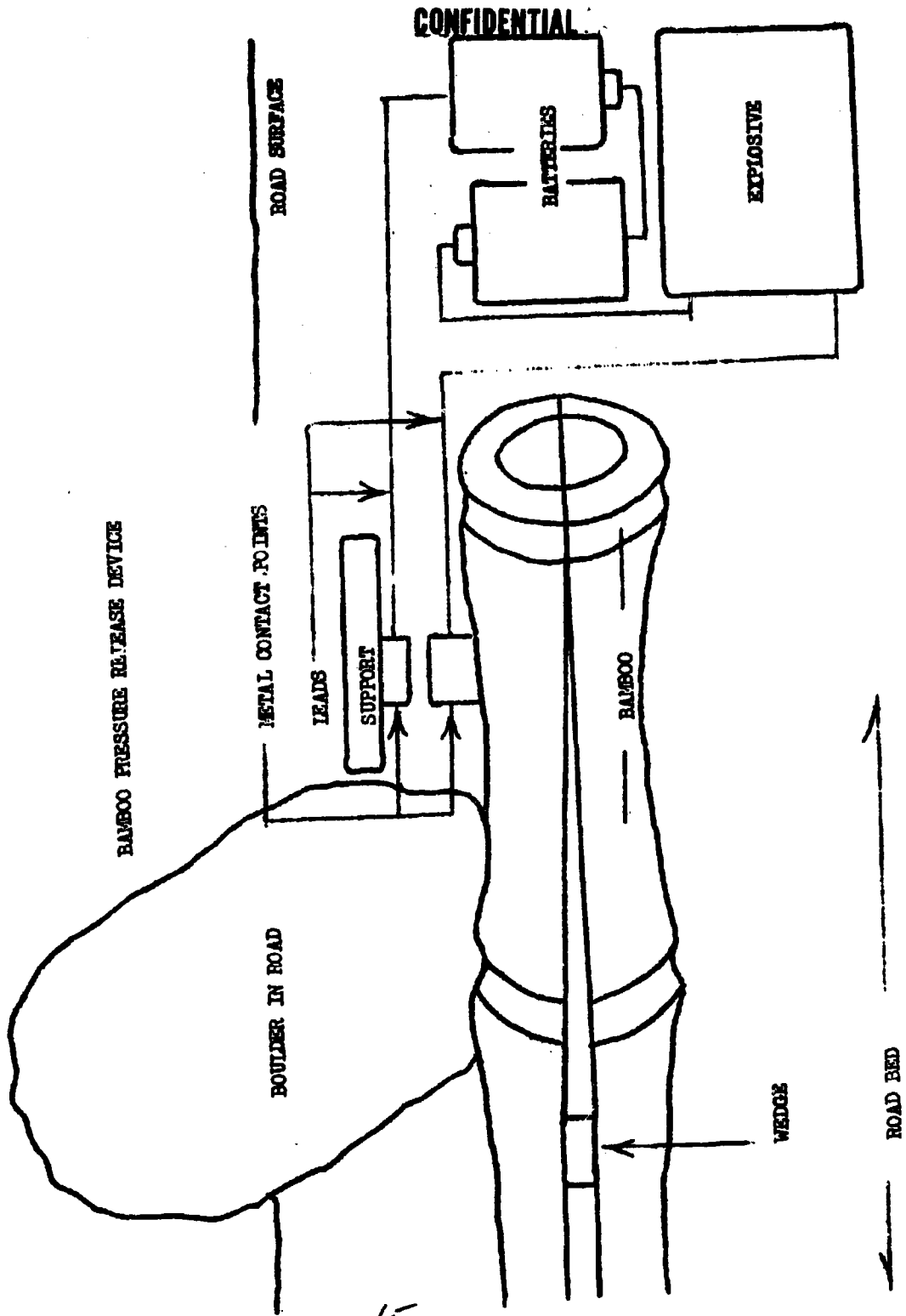

BAMBOO PRESSURE RELEASE DEVICE

METAL CONTACT POINTS

LEADS

SUPPORT

BOULDER IN ROAD

BAMBOO

WEDGE

ROAD BED

BATTERIES

EXPLOSIVE

45

48

CONFIDENTIAL

49

CONFIDENTIAL

TYPICAL ANTI-PERSONNEL VC TRIP WIRE BOOBY TRAP

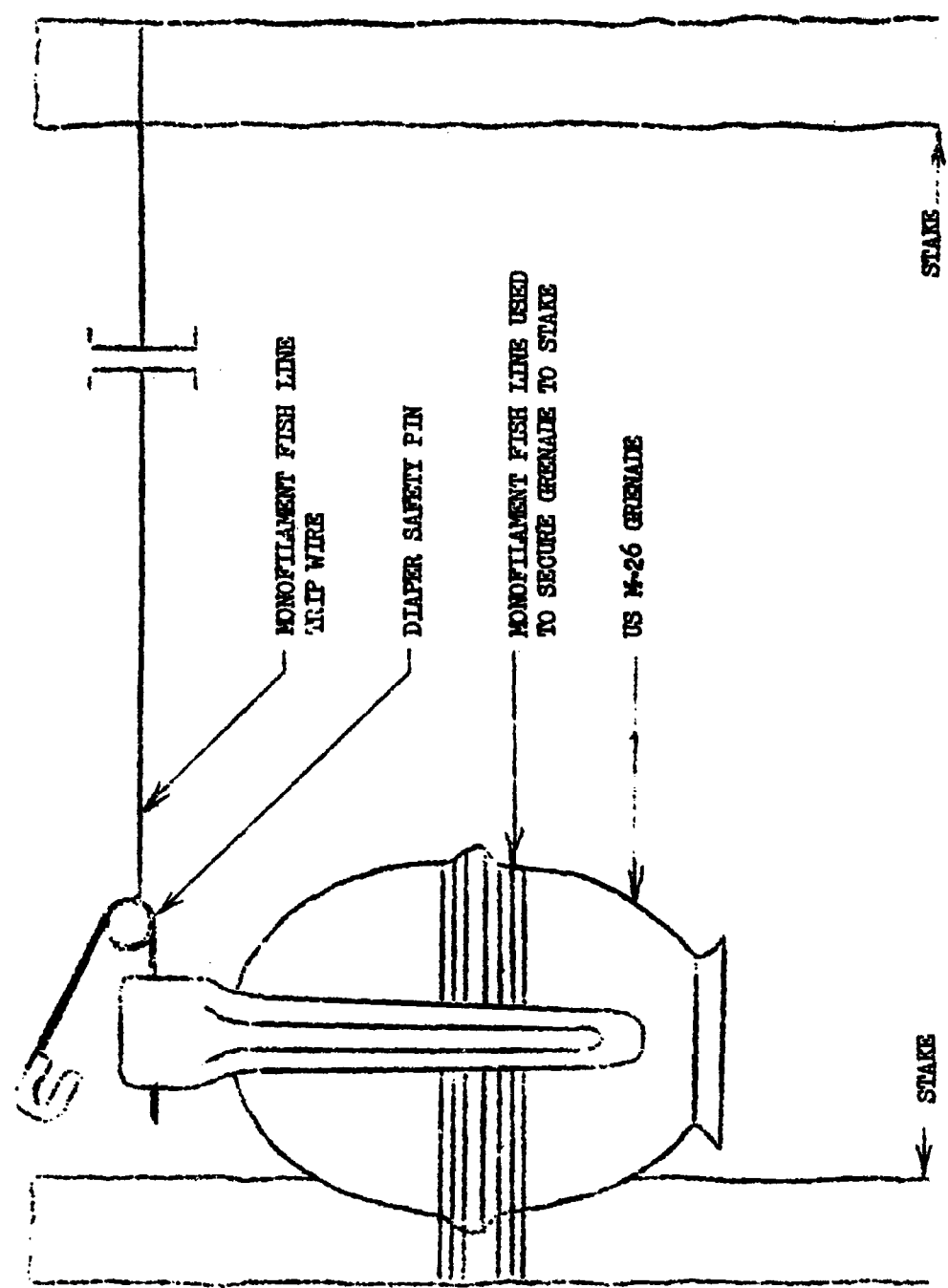

46

CONFIDENTIAL

SIMPLE LOBBY TRAP

47

CONFIDENTIAL

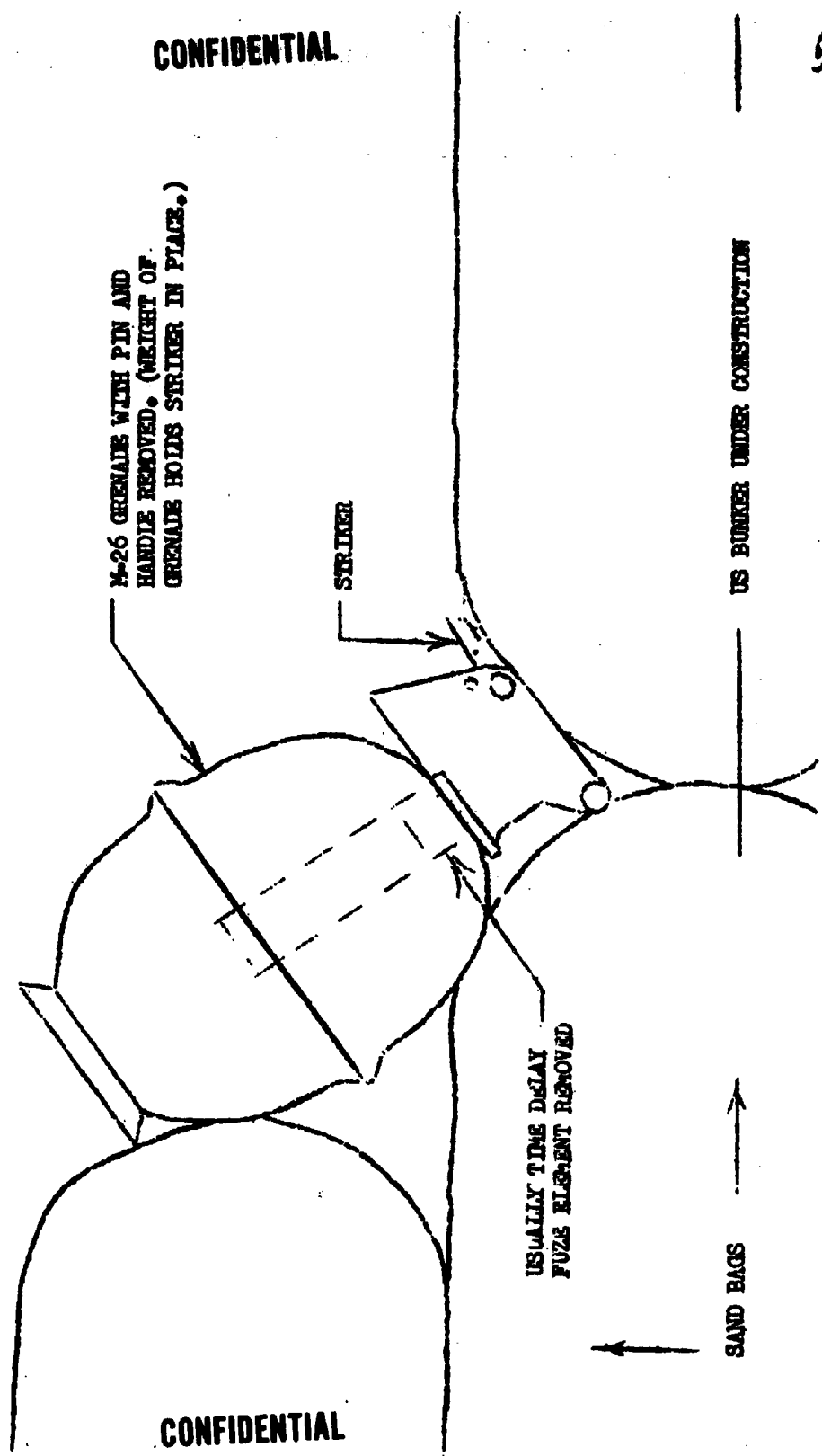

CONFIDENTIAL

50

CONFIDENTIAL

51

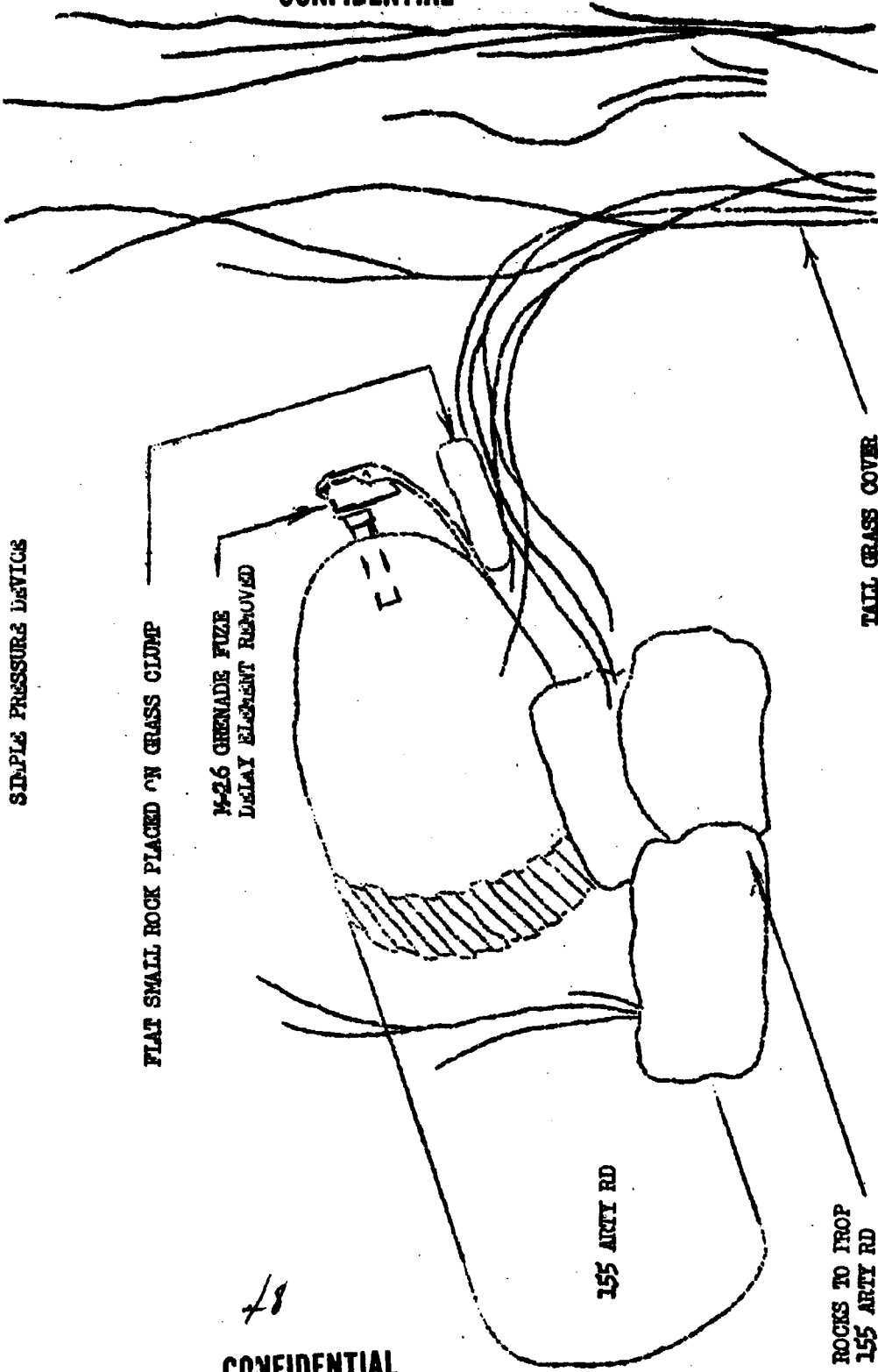

STAPLE PRESSURE DEVICE

FLAT SMALL ROCK PLACED ON GRASS CLUMP

M-26 GRENADE FUZE
DELAY ELEMENT REMOVED

TAIL GRASS COVER

155 ARTY RD

ROCKS TO TROP
155 ARTY RD

78

CONFIDENTIAL

CONFIDENTIAL

52

SQUA. KILLER - SIMPLE TRIP WIRE DEVICE

NOTCHED PLACEMENT OF DETONATOR PROVIDES MAXIMUM FRAGMENTATION EFFECT.

M26 GRENADE DETONATOR WITH PLASTIC BOOSTER

155 MM RD.

ROCK SUPPORT

TALL GRASS COVER

TRIP WIRE

STAKE

HILL SIDE SLOPE

49

CONFIDENTIAL

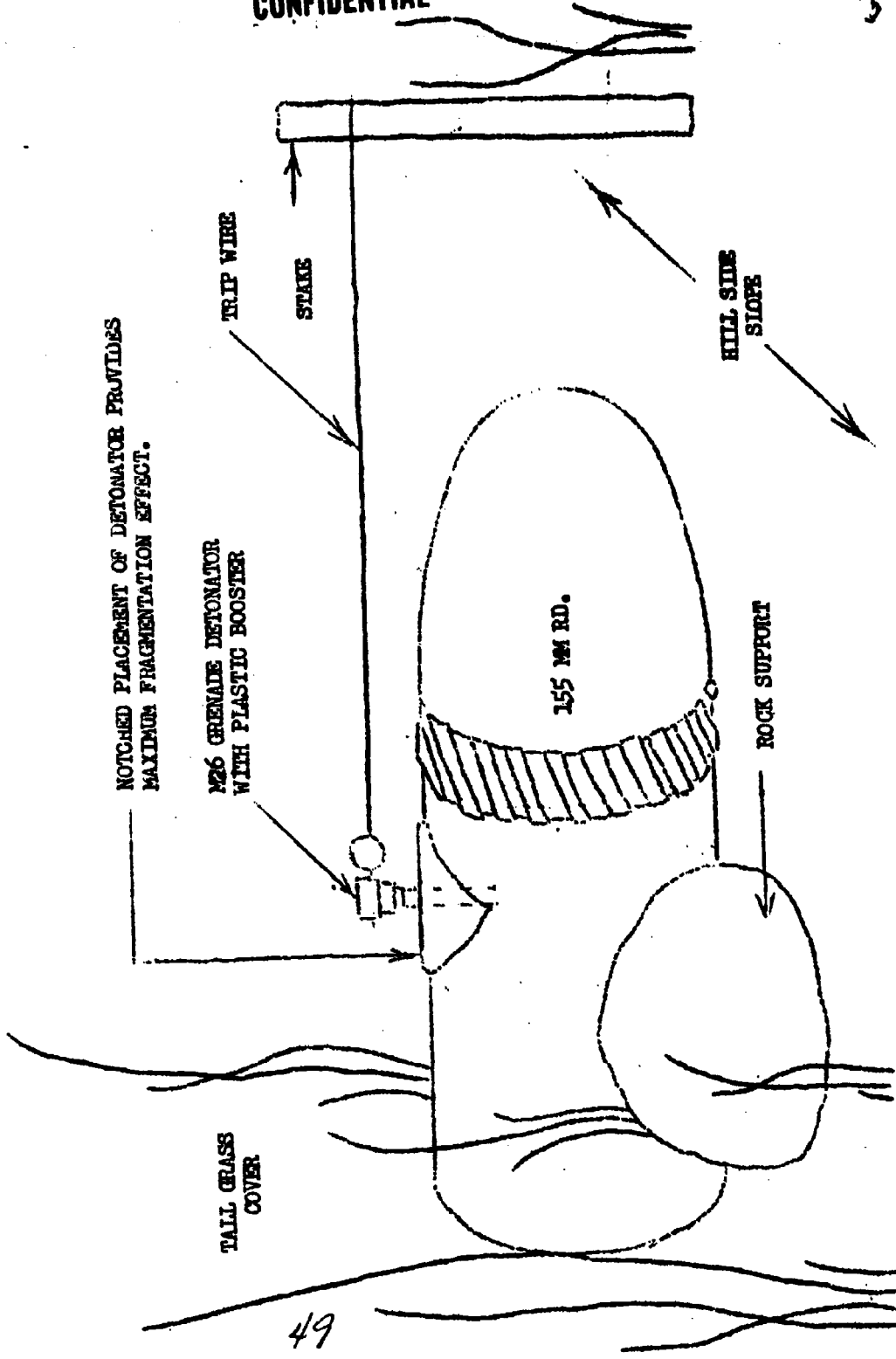

CONFIDENTIAL

53

AT & AP FULL WIRE TRIP DEVICE

CONCERTINA WIRE

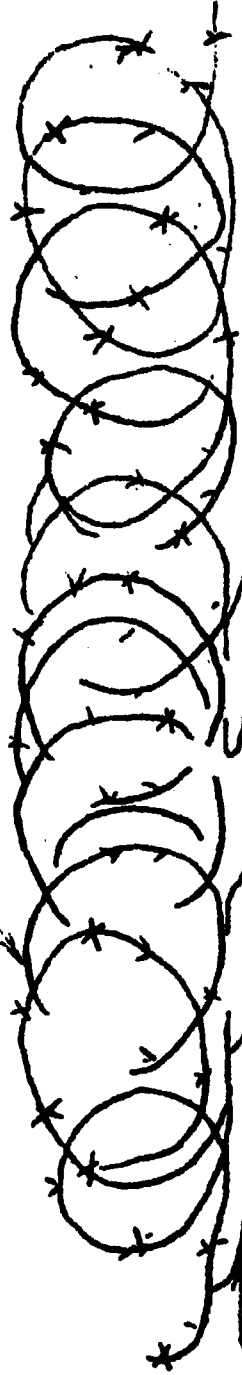

WIRE CONNECTING FULL
TYPE DETONATOR TO
CONCERTINA WIRE

BURIED
250 LB. BOMB

OLD TANK TRACKS

CONFIDENTIAL

50

CONFIDENTIAL

54

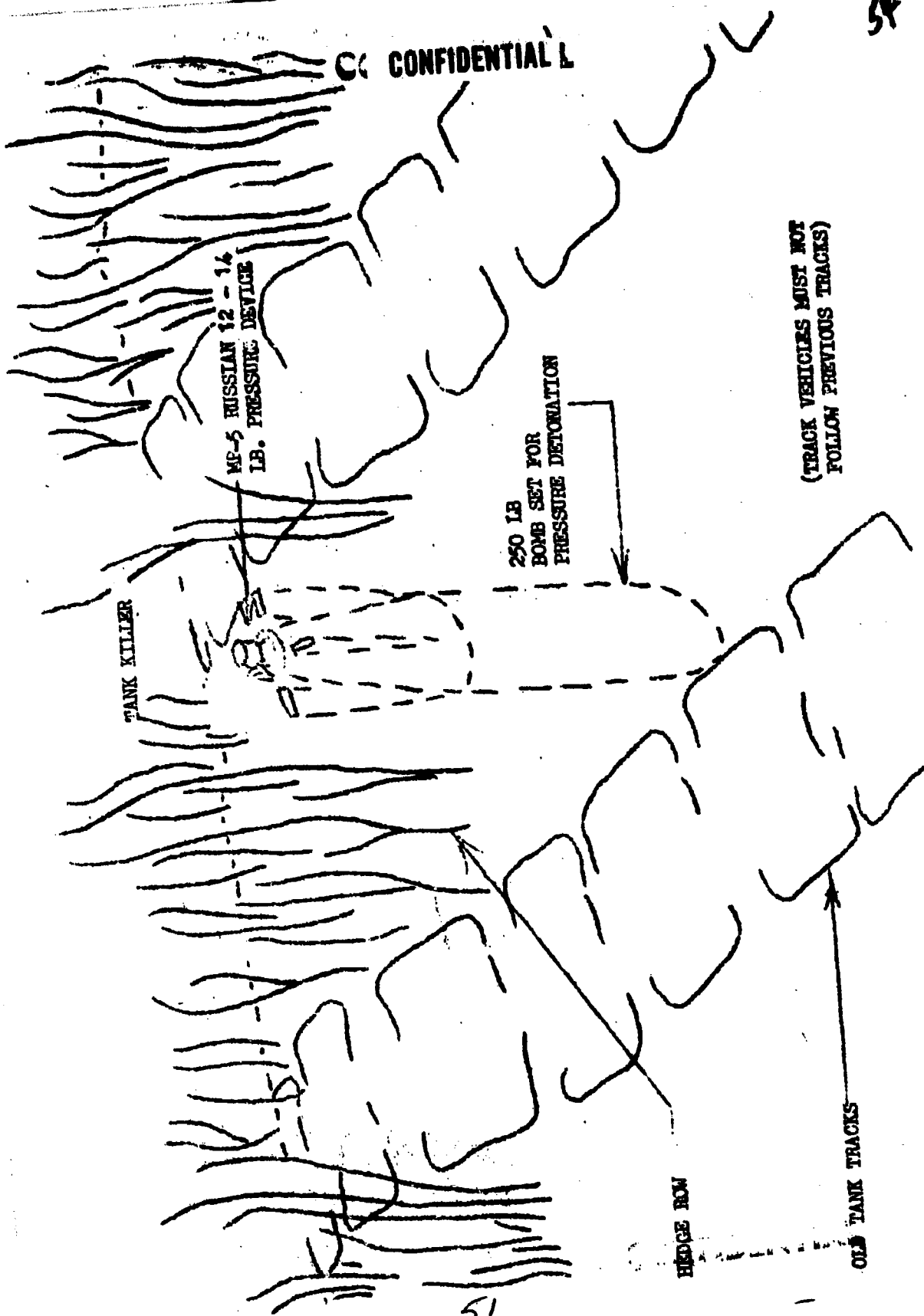

CONFIDENTIAL

51

55

CONFIDENTIAL

MP-5 RUSSIAN PRESSURE TYPE FIRING DEVICE

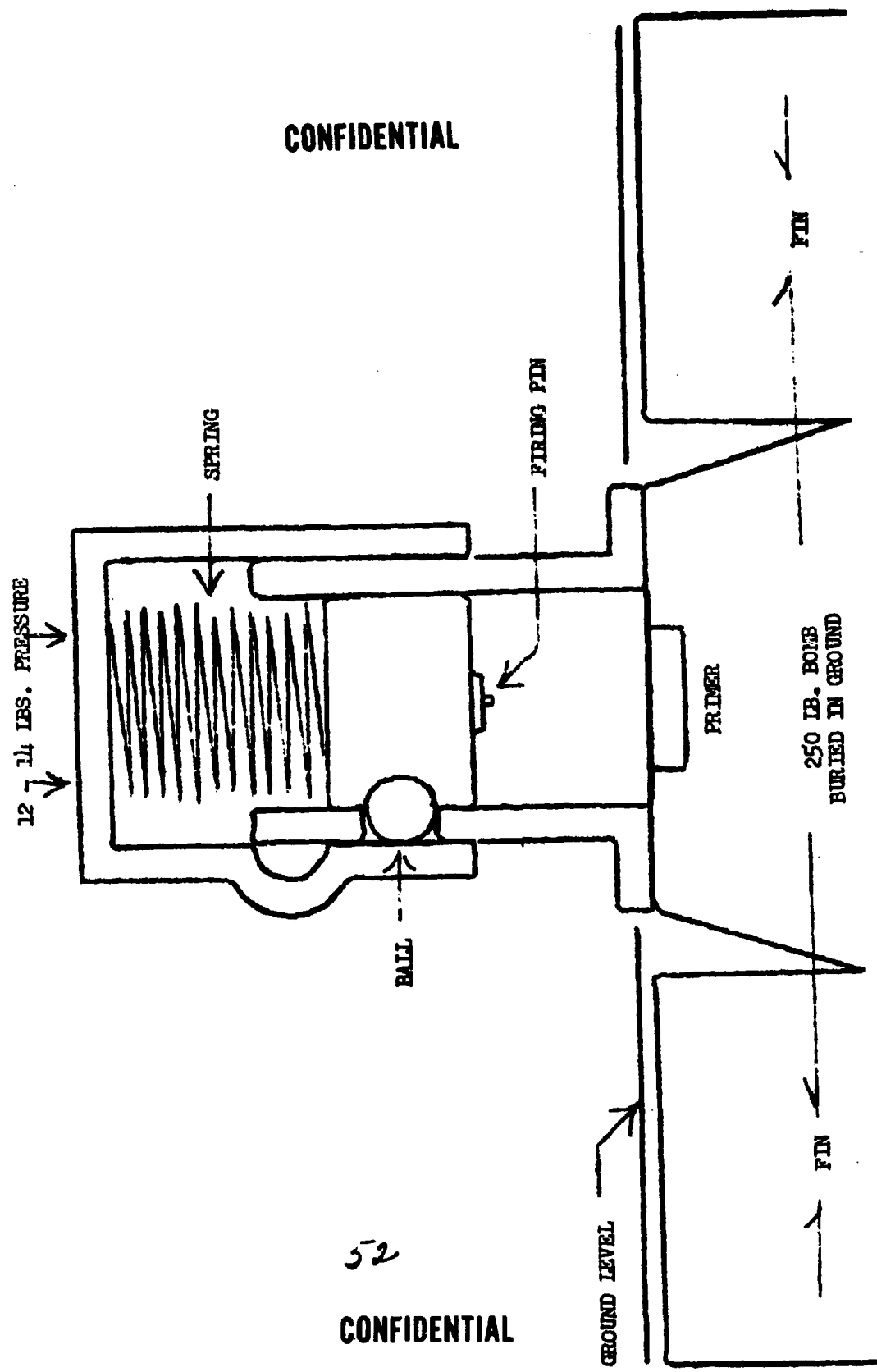

52

CONFIDENTIAL

MINING OF HIGHWAYS IN DUC PHO
(This one was found before detonation)

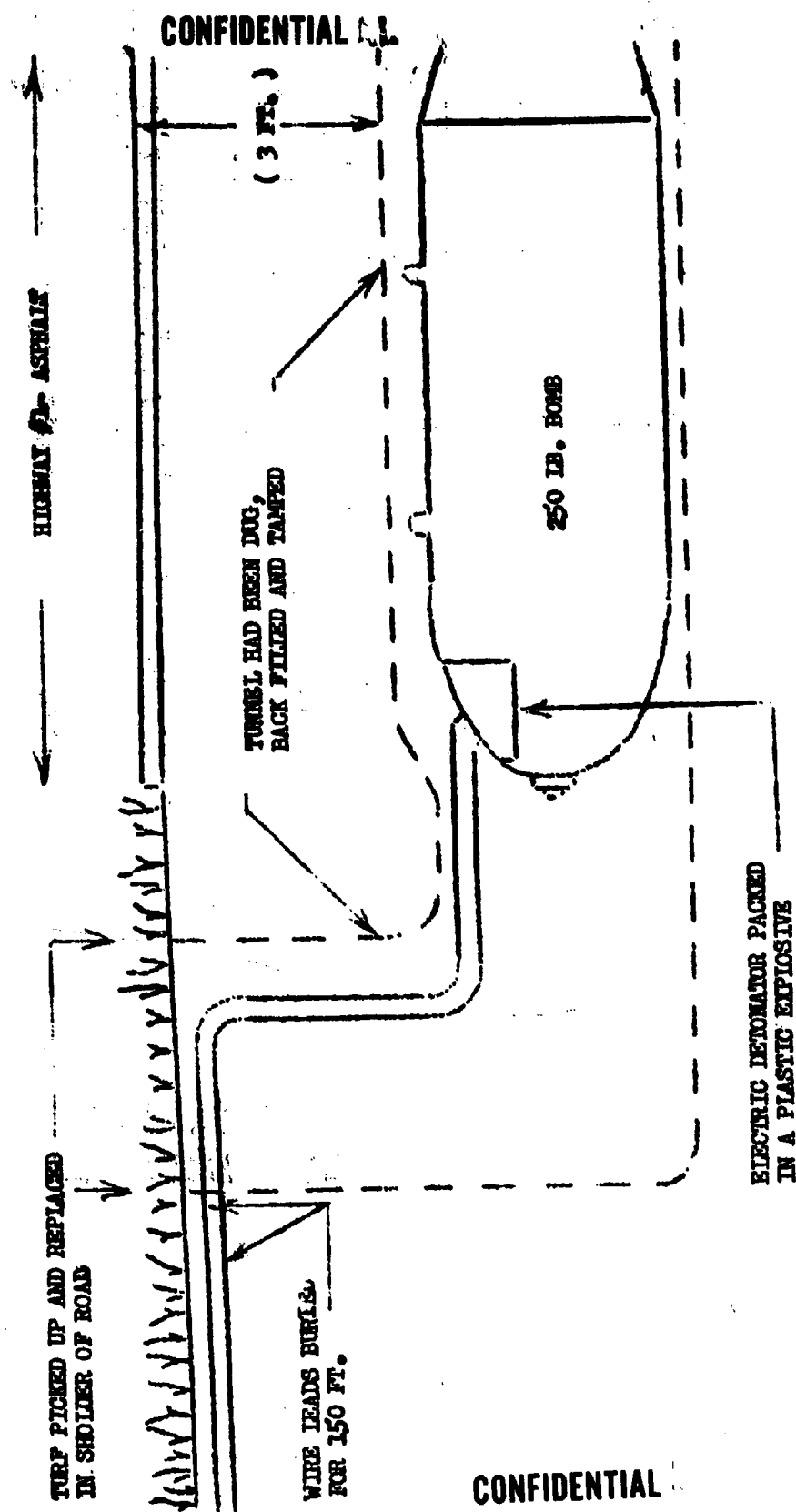

CONFIDENTIAL

56

HIGHWAY 4 - ASPHALT

TURF PICKED UP AND REPLACED
IN SHOULDER OF ROAD

(3 FT.)

TUNNEL HAD BEEN DUG,
BACK FILLED AND TAMPED

250 LB. BOMB

ELECTRIC DETONATOR PACKED
IN A PLASTIC EXPLOSIVE

WIRE LEADS BURIED
FOR 150 FT.

CONFIDENTIAL

53

57

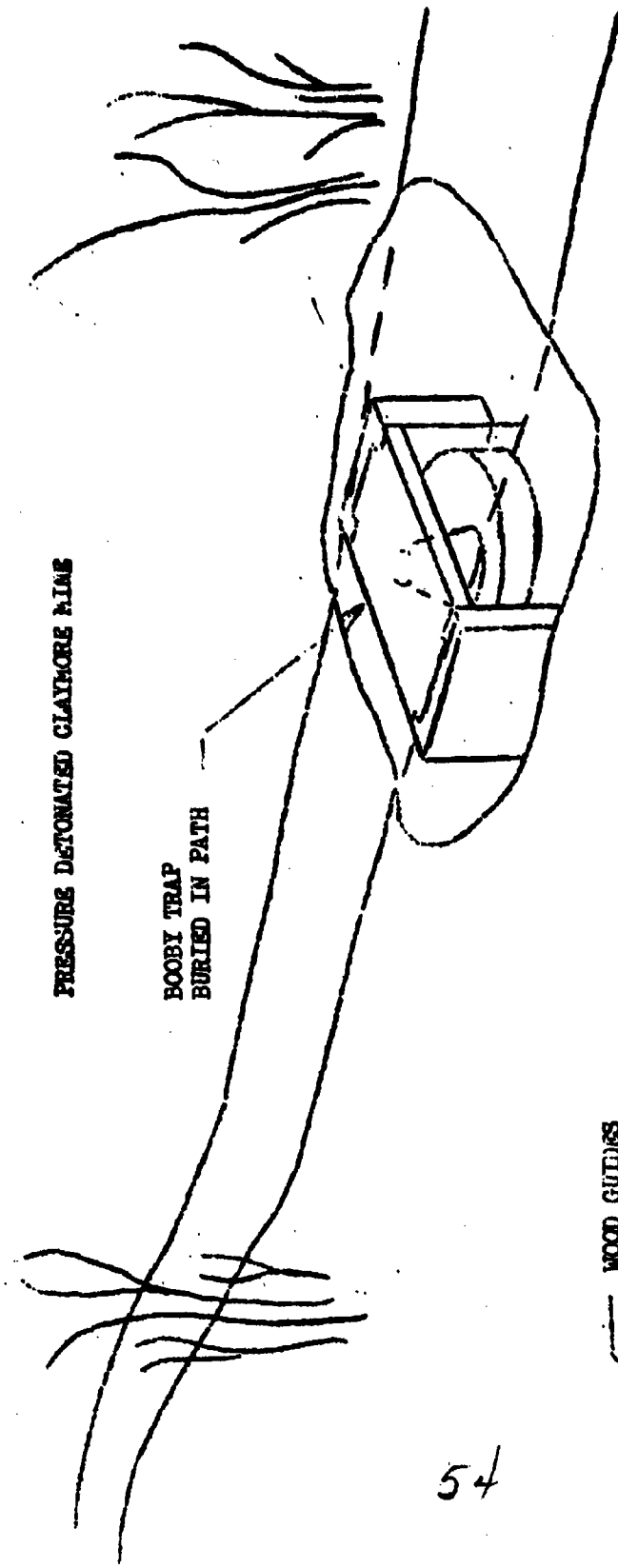

PRESSURE DETONATED CLAYMORE MINE

BOOBY TRAP
BURIED IN PATH

CONFIDENTIAL

54

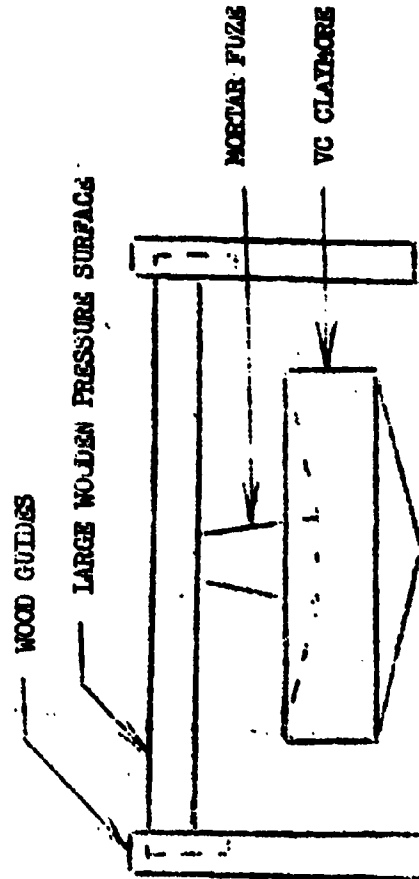

WOOD GUIDES

LARGE WOODEN PRESSURE SURFACE

MORTAR FUZES

VC CLAYMORE

CONFIDENTIAL

EXPLOSIVE FUNGI PIT

CONFIDENTIAL

58

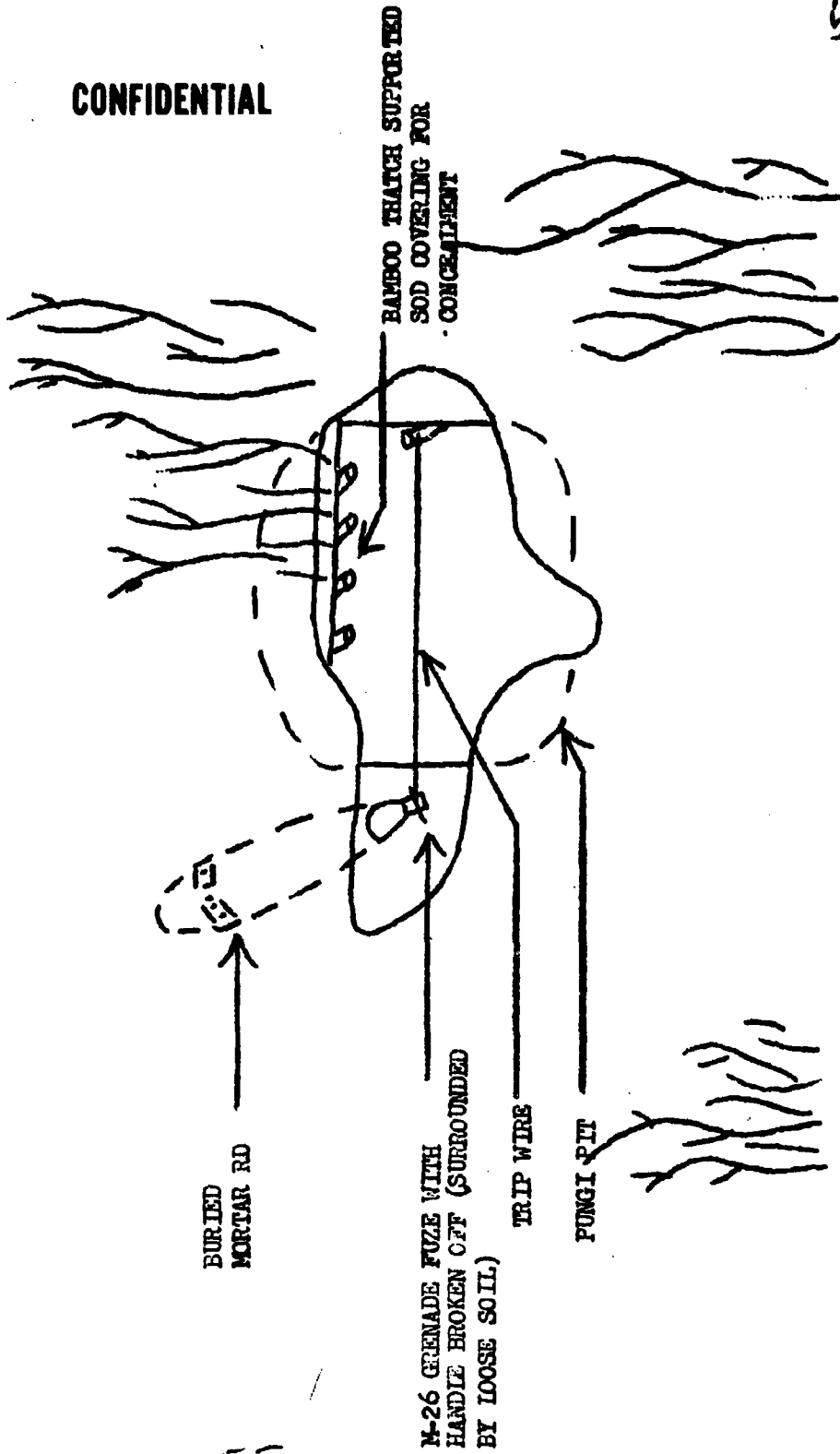

55

CONFIDENTIAL

59

CONFIDENTIAL AL

"CHICKEN CAGE" BOOBY TRAP

CAGE USED BY PEASANT TO
PROTECT PLANT OR PEN
CHICKENS. LEFT IN TRAIL
FOR GI TO KICK.

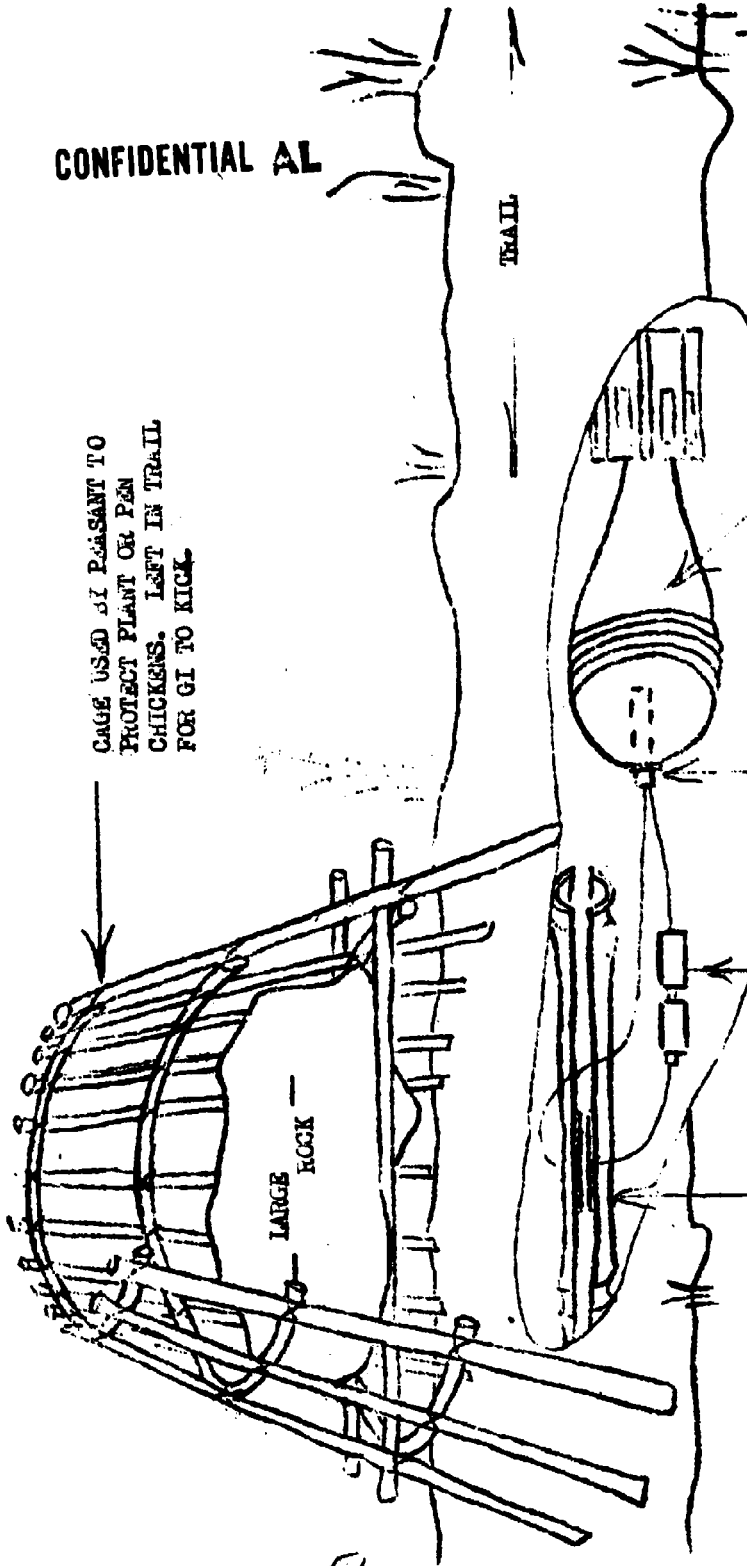

56

CONFIDENTIAL

2

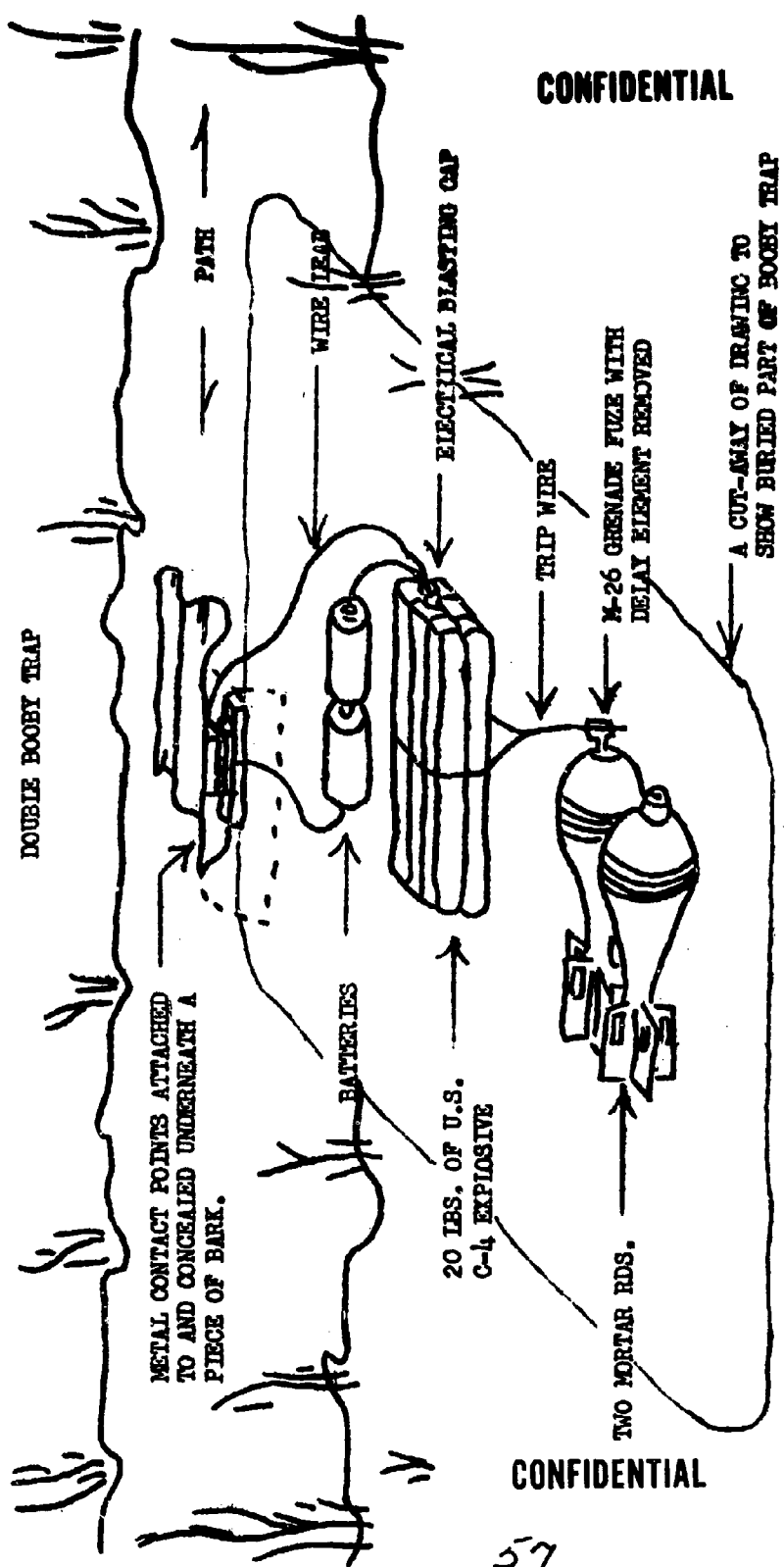

DOUBLE BOOBY TRAP

METAL CONTACT POINTS ATTACHED TO AND CONCEALED UNDERNEATH A PIECE OF BARK.

BATTERIES

20 LBS. OF U.S. C-4 EXPLOSIVE

TWO MORTAR HDS.

CONFIDENTIAL

57

CONFIDENTIAL

A CUT-AWAY OF DRAWING TO SHOW BURIED PART OF BOOBY TRAP

60

61

58

THIS IS A PICTURE OF AN EXPLOSIVE BOOBY TRAP THAT YOU FAILED TO DETECT. YOU WILL NEVER SEE IT.

CONFIDENTIAL

2ND BATTALION 35TH INFANTRY OPERATIONS

5 August 1967

SUBJECT: Search Technique.

The slogan "Find 'Em - Fix 'Em - Fight 'Em and Finish 'Em" is as true today as the day it was first promulgated; however, many units fail to put the sequence in proper order. So often this is true of our ARVN neighbors, they fix and fight only to learn they have nothing to finish. The unmatched success of this battalion lies primarily with finding the enemy first through the use of the deliberate search technique before we attempt to fix or fight. All operations are based on the most current intelligence, admittedly causing frequent changes in plans, but more often than not, yielding tangible results. The one true indicator of success is the actual number of enemy killed or captured and the number of enemy weapons seized. Since 10 July, this battalion has killed 260 enemy, captured 47 POWs and seized 108 weapons while suffering only 9 soldiers KIA. Our high body count and high weapons-to-kill ratio has resulted mostly from locating the enemy in his hiding places. Once he is located in this hiding place the job is relatively simple because the enemy has fixed himself by choosing a small tunnel with no route of escape. The enemy in this area has depended primarily on his advanced techniques of camouflage for protection. Once these passive measures fail, the enemy has no choice but to be killed or captured. Defense of a small hole, normally 18" by 18" against an American rifle squad is a difficult if not impossible task. This battalion has capitalized on the natural curiosity of the American by having our soldiers poke and probe every nook and cranny of the hedgerows around a village. We have learned that the most common hiding place for the enemy is beneath a bamboo thicket with a concealed trap door as shown in the enclosed sketch. As one can see, unless one actually places his hand on the bamboo stalks and pulls, the trap door will remain undetected. Some trap doors can be discovered merely by looking, but most are located by probing with hands and bayonets. To make the most effective use of the manpower available, the searching unit, normally a rifle squad, must sub-divide into a search team and a security team. Naturally, the curious should go to the search team while the less curious provide the security. The amount of enthusiasm generated by the platoon leader is almost directly proportional to the number of holes located. Many a hole has been located by the bleeding hand of a lieutenant or captain when the enthusiasm for the search had dwindled to a low ebb. Such leadership by example rekindles the searcher's enthusiasm and the race is on again to see who can locate the next hole. Once the hole is located, security is placed around the area and a systematic reduction of the area begins by first clearing away enough bamboo to allow the comparatively large American soldier to operate within the confined space. Next the hole is opened, normally by shooting through the door with an M-16 rifle. This is a strong deterrent to those enemy who would toss out a grenade at the unsuspecting soldier standing nearby.

Inclosure 3

59

CONFIDENTIAL

63

CONFIDENTIAL

Once the trap door is opened, various American and Vietnamese expressions are shouted into the tunnel exhorting the enemy to come out or be killed. Frequently the enemy will give up without a fight, saving us the effort not only of killing him, but of having to dig out the tunnel for weapons and documents. When all else fails and the hard core VC stays within the confines of his self-created tomb, a few strategically placed hand grenades normally reduces both the VC and the tunnel to rubble, leaving only the messy task of digging out the remains. The key to the success of this operation lies in the search technique of the individual soldier and his leader. This search method has paid off handsomely for this unit. We first "Find 'Em" by a slow deliberate search on the small unit level and then methodically "Fix 'Em", "Fight 'Em", and "Finish 'Em".

60

2

CONFIDENTIAL

CONFIDENTIAL

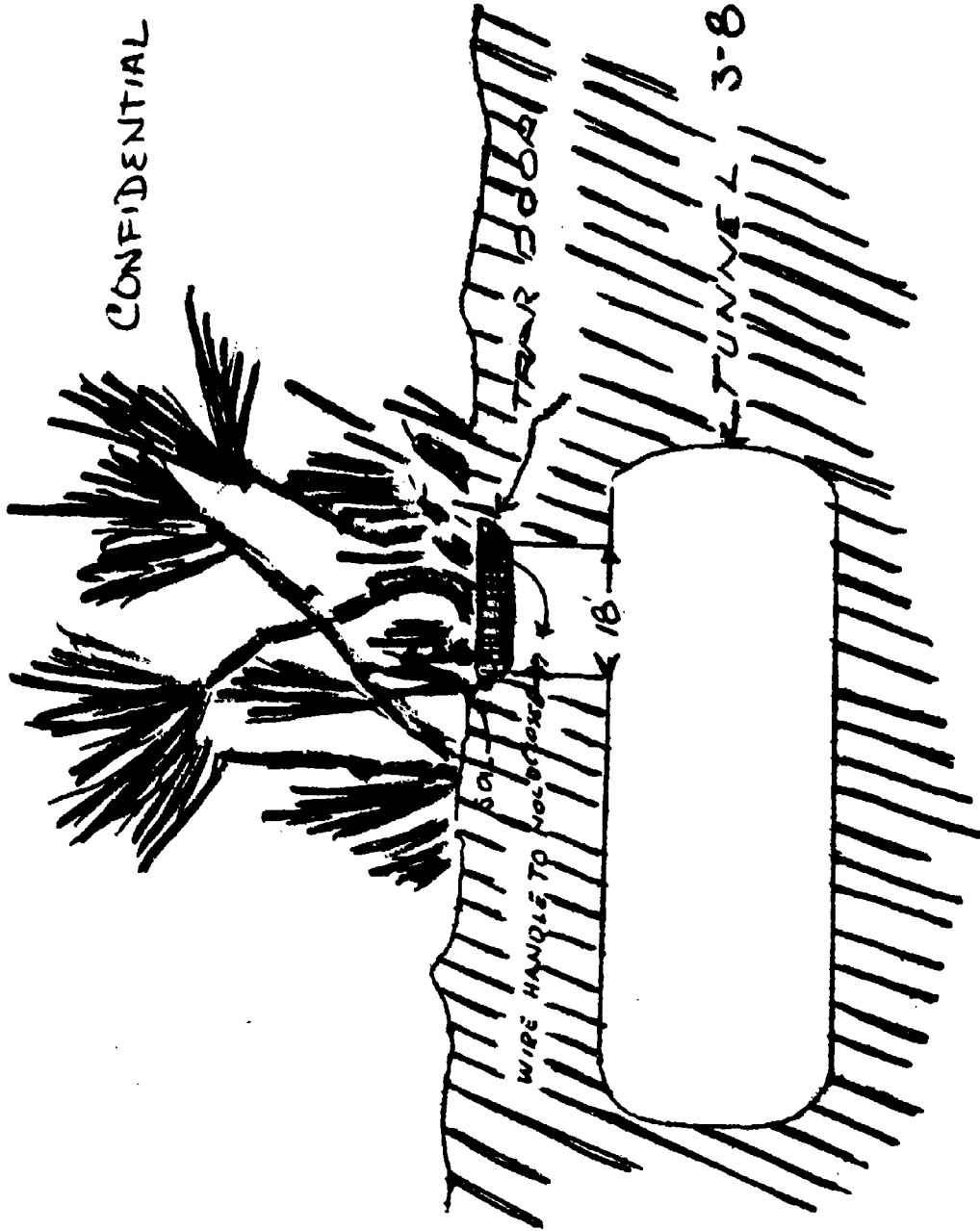

3-8 MAN SIZE

CONFIDENTIAL

61

68

CONFIDENTIAL

1ST BATTALION 35TH INFANTRY

5 August 1967

SUBJECT: Combat After Action Report for 15 July 1967

ASSAULT OF BUNKER POSITIONS

On 15 July 1967, Company C, 1st Bn 35th Inf, 3d Brigade 25th Infantry Division was conducting a search and destroy mission in the rugged terrain about 15 Kilometers SW of Duc Pho, Vietnam. The area in which the company was operating consisted of rugged mountains whose slopes were covered with thick jungle undergrowth. In most places the double canopy completely shuts out the sunlight. On this particular day the temperature was 103° and the men of Charlie Company were thirsty, hot and tired. The Battalion had received intelligence that an NVA Battalion was operating in the area. In an attempt to find the enemy and gain tactical surprise, the Battalion Commander, Major James E. Moore Jr., Mullan, Va., decided to infiltrate one of his companies into the area on foot with three days rations.

On the third day the company was moving south on two axes. The 2nd and 3rd platoons were on a high ridgeline with the company (-) moving parallel in the valley below. The 2nd and 3rd platoons were to swing down a finger to the east and link up with the remainder of the company. At about 1000 hrs the two platoons on the ridge began their movement downhill. The 2nd platoon was in the lead with the 3rd platoon following, echeloned to the left. At 1035 hrs the 2nd platoon commanded by 2nd LT Anthony M. Hassa, North Hollywood, California, approached an enemy bunker from the rear. The position was orientated to fire east down the finger. Three NVA ran from the the bunker and were quickly cut down. Two M16-47's and one Chiocom LMG were captured. (See map figure 1)

The platoons continued moving cautiously down the finger. Suddenly, the jungle erupted in a blase of fire. Two men were wounded in the initial volley. The enemy had evidently allowed them to get within 15-20 meters before they opened up. According to PSG Jack H. Jasper, Lawton, Okla., the plat Sgt 2nd plat, "The fire was so intense that no one could move - if he did he was hit. We had nine men hit in the first 30 minutes. The men were magnificent - they followed orders and operated like machines. As the firepower built up the enemy fire decreased. We fired sixteen M-72 LAWS during the firefight. I'll never be without LAWs again, they are a good weapon. I don't know how many we killed but I do know those LAW's really hurt the PAVN's". (See figure 2).

The third platoon maneuvered to the left in an attempt to flank the enemy. However, it wasn't long before they too were heavily engaged with two enemy bunkers. (See figure 3). The 3rd platoon leader, 2nd LT James H. Smith, Patterson N. J., was hit in the arm. He picked up a 45 cal pistol and assaulted one of the bunkers. He was hit again in the left leg and was pinned down by the heavy fire. SP/4 Lawrence W. Ireland, Houston, Texas the platoon medic, ran through the enemy fire and carried LT Smith back to a covered position where his wounds could be tended.

Inclosure 4

62
CONFIDENTIAL

CONFIDENTIAL

In the meantime, CPT John H. Cavender, Waycross, Georgia, the company Commander, was bringing his 1st and 4th platoons up the finger in an attempt to close the pincer on the enemy. The 4th (Wpa) platoon was being used as a rifle platoon for this operation. (See figure 4). His elements were fired upon by a lone rifleman at the base of the finger. When fire was returned the enemy fled. The vegetation in this area was so thick that the elements with the Company OP were forced to move on the narrow trail. CPT Cavender sent the 1st and 2nd squads of the platoon toward a small knob east of the enemy to act as a blocking force. (See figure 5). He then maneuvered the remainder of the 1st platoon and the 4th platoon to the north of the enemy. (See figure 6). When this had been accomplished he moved forward with a squad to locate the enemy positions and determine his course of action. At this time the men of Charlie Company believed there were only two enemy bunkers, the ones that were engaged with the 2nd and 3rd platoons. Upon approaching the position from the rear, CPT Cavender and the squad began to receive heavy automatic weapons fire from the left front, resulting in several casualties.

The Battalion Commander, Maj Moore and his S-3, Major Gerald L. Tippen, Columbus, Ohio, had been in the air over the battle since 1100 hrs. CPT Cavender requested an ammo resupply and medevac for two seriously wounded men while he completed his maneuver and brought forward his 90mm RR. There were no landing zones in the area, so at 1230 hrs, one squad from the 2nd platoon pulled back 100 meters to care for the wounded and assist in the resupply. (See figure 7). The Battalion Commander requested a medevac helicopter with a hoist and also a badly needed resupply of ammunition. Meanwhile, the squad from the 2nd platoon began clearing the underbrush for the medevac and the resupply drop. Minutes later, the Bn Cmdr returned, the command and control helicopter flew down and hovered at tree top level while the ammunition was dropped to the waiting men below.

The 3rd platoon, using M-72 LAWs, maneuvered and destroyed the two bunkers to their immediate front. By this time they were receiving heavy fire from further to their east. Because of the dense vegetation and the proximity of US troops, artillery was not feasible and Huey gunships could do little through the thick jungle canopy. Maj Moore talked to the company Commander concerning the feasibility of pulling back and bringing in TAG air. CPT Cavender stated that the enemy fire was so heavy and accurate that he felt he would sustain more casualties by withdrawing. He also had all escape routes cut off and was waiting for his 90mm recoilless rifle to be brought forward for a direct shot at the enemy bunkers. At this time it appeared as if the fire was coming from one or two positions that were situated in the saddle.

The disposition of Charlie Company was as follows: The 2nd and 3rd platoons were west of the enemy position. Two squads of the 1st platoon, the 4th platoon and Company OP group were to the north and two squads from the 1st had laboriously worked their way up to the knob to the east. The only gap in the encirclement was to the south, but it was covered effectively by fire from the 2 squads east of the enemy positions.

63
2

CONFIDENTIAL

CONFIDENTIAL

67
By 1420 hrs the medevac ship had arrived and evacuated two of the wounded by hoist. At this time, however, there were 14 more wounded which had been brought to the area from which the original medevac was made. The Bn Surgeon CPT. Carroll P. Osgood, West Hartford, Connecticut, volunteered to be lowered into the battle area to care for the wounded and organize their evacuation. On the medevac's third trip, the doctor was lowered into the area, with much needed blood plasma, and another wounded man was evacuated. Unfortunately the hoist on the medevac ship broke, so a CH-47 Chinook was requested to hoist out the remaining wounded. When it arrived four more wounded men were hoisted aboard. The Brigade Surgeon, CPT. Dennis E. Lee, St. Louis, Mo., was on the CH-47 Chinook with medical personnel and as soon as the wounded were lifted aboard, their treatment began. The hoist was not working properly and the Chinook hovered for 45 minutes in the battle area while the men were being extracted. As the fifth casualty was being lifted the hoist stuck in place. The Chinook proceeded toward the 25th Med hospital with the wounded man dangling some 50 feet below. Maj Moore then directed the Chinook to an open area and landed his ship. The man was removed from the hoist and taken to the medevac center by the Bn Commander's helicopter. Because of the soldier's condition this action probably saved his life.

While the Chinook was extracting the wounded the company attempted to neutralize the bunkers using LAWS and the 90mm recoilless rifle. The thick vegetation hampered these efforts, although they did get several direct hits. By this time Charlie Company had 17 wounded. Captain Cavender decided, therefore, that he could no longer afford to continue the stalemate. The enemy fire was extremely accurate and his casualties had been steadily increasing. It seemed as though everytime one of the men exposed himself he was hit by the unseen marksman. Therefore, while the hook was making the final extractions, CPT Cavender organized his men for a final assault. At 1600 hrs, using the 2nd and 3rd platoons as a base of fire, CPT Cavender led the two squads of the first platoon in the final assault. The assault wave rose up as one man. Shouting and screaming at the top of their lungs they closed on the enemy positions. The violent assault was so effective that some of the enemy fled from the bunkers, others were found cowering in their holes. As the men ran forward they threw hand grenades in the enemy bunkers, and cut down the fleeing enemy. It wasn't until the positions were overrun that the men from Charlie Company realized that there were five large bunkers arranged in a circle instead of the one or two they had expected to find. (See figure 8). In and around the bunkers 25 NVA bodies were found along with 6 AK-47's, 3 ILM's, 2 SKS, 1 Mouser and several grenades.

1/LT David W. Hockett, Marango, Iowa, platoon leader of the 4th platoon, led his platoon in the final devastating charge. He said, "About 1600 hrs the CO informed me that my platoon and two squads from the 1st would assault the enemy position. I organized my platoon into two waves; instructing the 2nd wave to fire in the trees above the first wave. I was in the middle and the CO was on the right. On the signal we moved out; after a few meters, enemy fire became intense and the line began to waver. At this time CPT Cavender let out with that "Georgia Rebel Yell" of his and that relieved the tension. The men picked up the cry

3
64
CONFIDENTIAL

CONFIDENTIAL

and we surged forward through the enemy positions.

"As I broke through the thick foliage I saw Sgt Michael H. Mortenson, Chicago Ill, assaulting two bunkers under the covering fire of Dale W. Kindred, Arrowsmith, Ill. Kindred was firing directly into the apertures of the bunkers as Mortenson ran forward and threw in grenades."

"SF/4 Clyde F. Walker, Corinne, Utah, jumped into the last bunker, screaming and using his rifle as a club - he was hit three times by the remaining NVA inside, he got one; then we pulled him out and tossed in two grenades - that finished the fight. It was suddenly very quiet, there were dead NVA all over the place. There is no doubt in my mind that once we started yelling the battle was ours. I felt then that nothing could stop us".

Sgt Mortenson said, "I don't think we could have taken the position without the final charge. I already had three men in my fire team hit. Once we saw the bunkers and started yelling, those gooks must have known they were dead - They had nowhere to go and nothing to do but die".

After the battle CPT. Cavender said, "This battle was won by the men, not artillery or air power - but the infantryman who were willing to close with and destroy the enemy. They did everything I asked of them and more. Once we started our assault I knew that it would soon be over, and victory was ours".

"The longer we stayed where we were, the more casualties we were taking. I have never seen enemy fire so accurate. It seemed like everytime a man moved he was hit. We were too close for artillery and air, and we couldn't pull back without taking a lot of casualties. I know "Charlie" was surprised when we charged. His fire was still heavy - but not as accurate and we could see some of them trying to run out of their holes. When I heard the men and saw the determination on their faces - I was proud to be an infantryman and their company commander. I sure wouldn't have wanted to be in one of those bunkers. I still prefer to use our basic concept of finding and fixing the enemy - then use all the artillery and air we can get. However, I feel that on that day I fulfilled a company commanders dream - to lead his men in an overwhelming, successful assault of an enemy fortified position. We learned an important lesson that day and that is that an aggressive, well trained American rifle company is the ultimate weapon."

This action by Co C is an outstanding example of the application of fire and maneuver plus the use of organic direct fire weapons. No artillery, air, or gunships were employed. Support was not used due to the close quarters fighting with infantryman engaged within 15-20 meters of the enemy. Of particular note was the final assault in true infantry style, through heavy enemy fire, and the fact that only one man was wounded.

Company C had a total of 18 casualties, two of whom subsequently

4

CONFIDENTIAL

65

CONFIDENTIAL

69
died of wounds. The remainder of the wounded were not serious. After the battle the area was policed and the company moved back down the finger to the east, to their night location. Here, the remaining six walking wounded were extracted. (See figure 9).

The Battalion's normal concept of operations has been to use the infantry to find and fix the enemy. Company C had been in many other battles where the enemy body count was much larger and their casualties were fewer. However, the men were proud of this victory, as they had met an NVA platoon in prepared positions, fighting on the enemy's own terms, and defeated him as Infantrymen.

5

CONFIDENTIAL

66

CONFIDENTIAL

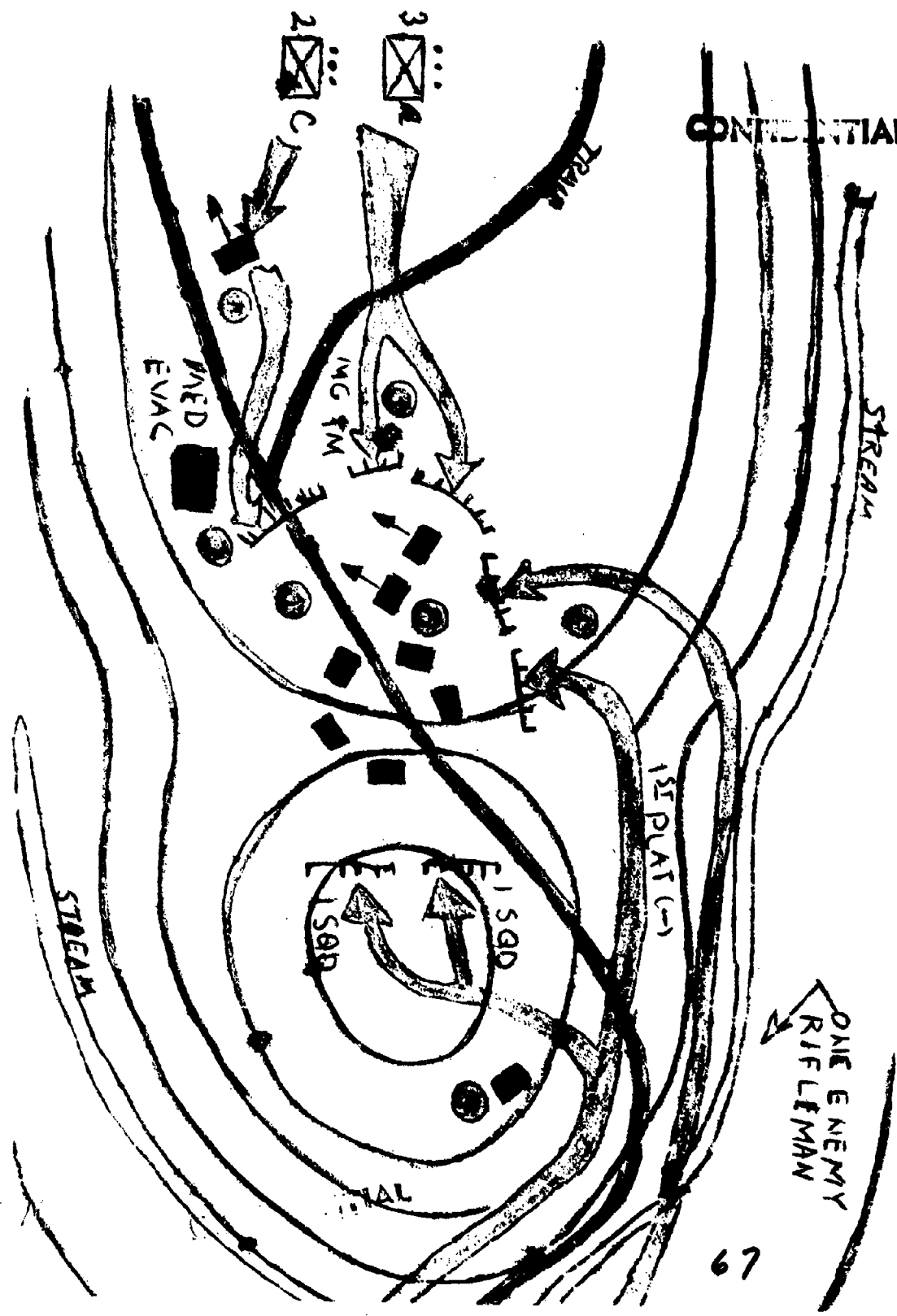

CONFIDENTIAL

2ND BATTALION 35TH INFANTRY OPERATIONS

71
AVDC-C-OP

5 August 1967

SUBJECT: Combat After Action Report for the period 19 May thru 20 May 1967

THE BATTLE OF VINH MIEN

While in the process of securing an LZ, vic 775457, at 191545H May 1967, in preparation for a combat assault in support of C/2/35, in contact to the north, A/2/35, began receiving enemy automatic and small arms fire from three or four enemy positions to their north. The CO, A/2/35, decided with the concurrence of the Battalion Commander, to attack these enemy positions and to further develop the situation. The initial enemy fire wounded one soldier seriously. Moving to the south, A/2/35 overran the enemy positions, killing two enemy. By 1610H, the enemy had disengaged and had retreated to the southwest. A sweep of the contact area produced an FM Radio, medical supplies and several NVA uniforms. They continued the search and then, upon receipt of information of enemy movement to the southwest, began a sweep in that direction.

At 1735H, A/2/35 again received some small arms fire from the south. Realizing that his company might be led into an enemy ambush, CPT Barcena, CO, A/2/35, requested and received an air observation team from B/1/9 Cav (airmobile) to screen his flanks and front. Continuing to move to the south, A/2/35 was again fired upon at 1830H from the south. The observation team located the enemy and directed the company along a concealed route to the enemy position. The position was destroyed and two enemy were killed. One Thompson sub-machinegun was captured. At 1910H Company A closed for the night, vic BS774455. At 1915H, one VC sniper fired at and wounded one of the company's riflemen. The VC was killed and his weapon captured. The company dug in and listening posts were put out. The wounded soldier was evacuated.

At 200025H, the CO, A/2/35, reported that his LP's to the northwest and southwest had engaged a total of eight enemy. The LP's threw grenades, detonated their claymores and fired their weapons. Two enemy with grenades were killed; the other six fled. The LP's shifted their locations and waited. A sweep was conducted by one of the platoons but they only discovered three blood trails and the two enemy killed. The blood trails indicated that three enemy were seriously wounded.

At 0147H, CPT Barcena reported his perimeter under attack by an estimated enemy company. Using existing trench lines that encompassed the entire area, the enemy was able to move undetected to within a few meters of where the LP's had been. The enemy, thinking the LP's were there threw grenades and attacked the empty positions. This brief warning enabled the LP's to ambush the attackers and move back to their lines. By this time artillery defensive concentrations were being fired. Despite the heavy volume of outgoing fire, the enemy pressed forward in a vigorous ground attack. Using the "hugging" tactics to avoid the heavy artillery concentrations, the enemy threw large numbers of hand grenades into the perimeter. It was these hand grenades that inflicted most of the casualties. Flareships and gunships were requested. By 0222H the enemy had ceased the coordinated ground attack and was engaging A/2/35 on only the northern flank. DUSTOFF, aeromedical evacuation, was alerted to stand by to evacuate the wounded once the area was secured.

Inclosure 5

68

CONFIDENTIAL

CONFIDENTIAL

5 August 1967

SUBJECT: Combat After Action Report for the period 19 thru 20 May 1967

72

At 0247H, CPT Barcena requested a resupply of ammunition. LTC Granger, realizing that a resupply helicopter would, in all probability, be shot down in the attempt, decided to commit C/3/4 Cav (-); not only to carry the much needed ammunition, but also to block the southern escape route. Under the light from the 105mm illuminating rounds, C/3/4 Cav (-) departed LZ LIZ. At 0355H, the armed AC-47 "Dragonship" arrived on station and rained accurate fire on the enemy. The aircraft commander of the AC-47 also guided the APC's along the best route of advance toward the besieged company. At 0418H, Co A reported ten WIA and requested medevac for them. By 0427H, DUSTOFF was overhead and going into the LZ. Receiving AW fire the helicopter had to pull out, unable to extract any of the WIA's. He flew to LZ LIZ to check his helicopter for damage and to await the time when he could again attempt the extraction.

C/3/4 Cav closed A/2/35's perimeter without incident at 0451H. Just prior to the closing, the enemy fired rifle grenades and small arms sporadically throughout the perimeter. Contact was broken on the arrival of C/3/4 Cav. Additional resupply was requested and the resultant resupply helicopter and DUSTOFF extracted the twelve WIA's and two KIA's. See sketch #1.

Between 0630H and 1210H, there was no enemy contact. A/2/35 and C/3/4 Cav conducted an extensive search and sweep in the night area of contact, locating 10 enemy killed and 3 weapons. In addition, one hamlet guerilla was captured. Upon interrogation, it was discovered that he was wounded during the initial probe at 0025H. He observed two others in his group killed. At 0900H, A/2/35 located a VC Bunker Complex 100 meters west of their night location. An engineer squad from D Company, 65th Engineer Battalion, was airlifted with explosives to the LZ and was carried by an APC to that location. Elements from both C/3/4 Cav and A/2/35 provided security while the engineers worked on the destruction of the VC Camp and its bunker complex. See Sketch # 2.

At 1221H, this work party came under attack by the enemy. Firing RFG-2's the enemy hit one of the APC's killing the track commander and driver. The APC was destroyed. In reinforcing the engineer work party A/2/35 (-) and C/3/4 Cav (-) met heavy enemy resistance but aggressively fought through it driving them to the southwest. At 1341H, C/2/35 was alerted to move to a pick-up site where they would be extracted for a combat assault to the southwest. The Battalion Reconnaissance platoon was alerted to move from LZ LIZ to vic BS768463. At 1410H an airstrike helped to break up the enemy concentration. By 1448H, Recon/2/35 Inf was in position and by 1500H, C/2/35 (-) had conducted their combat assault into an LZ vic BS786443. While elements were being moved into position, a FAC spotted twenty armed enemy moving toward the destroyed APC. While the Battalion Commander adjusted the fire of the 106RR from LZ LIZ, CPT Barcena sent a ground element toward the enemy position at the APC. When troops arrived at the destroyed APC they killed two more enemy, one of them inside the track.

C/2/35 (-) moved from the landing zone to the east linking with A/2/35. By 1540H, C Company was in contact with a well entrenched enemy southwest of A Company. During a stiff village fight that lasted more than an hour C Company killed twenty-six armed enemy. Meanwhile, A Company and C Troop 3/4 Cav had turned to the east and were pushing through the southern edge of Vinh

69

2
CONFIDENTIAL

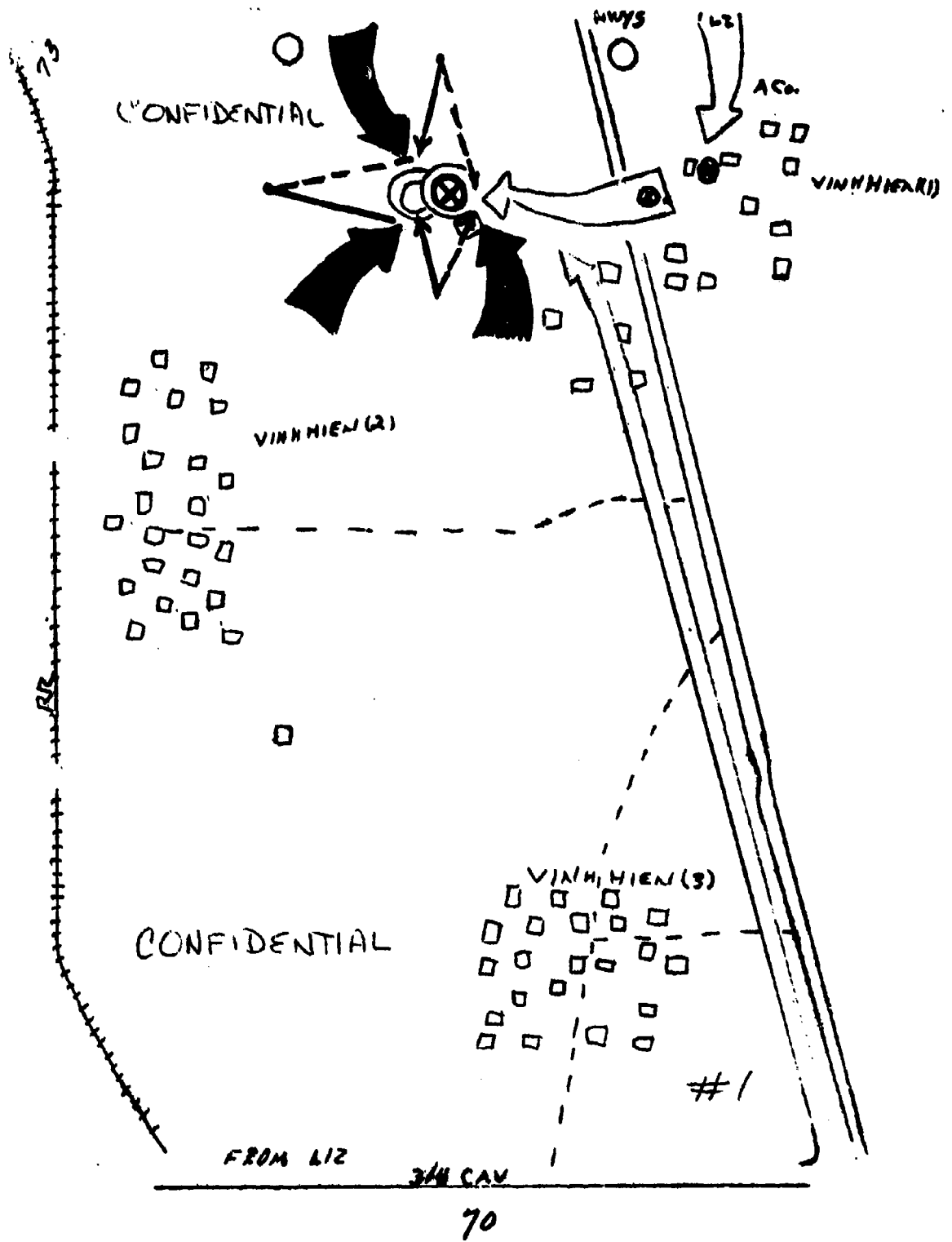

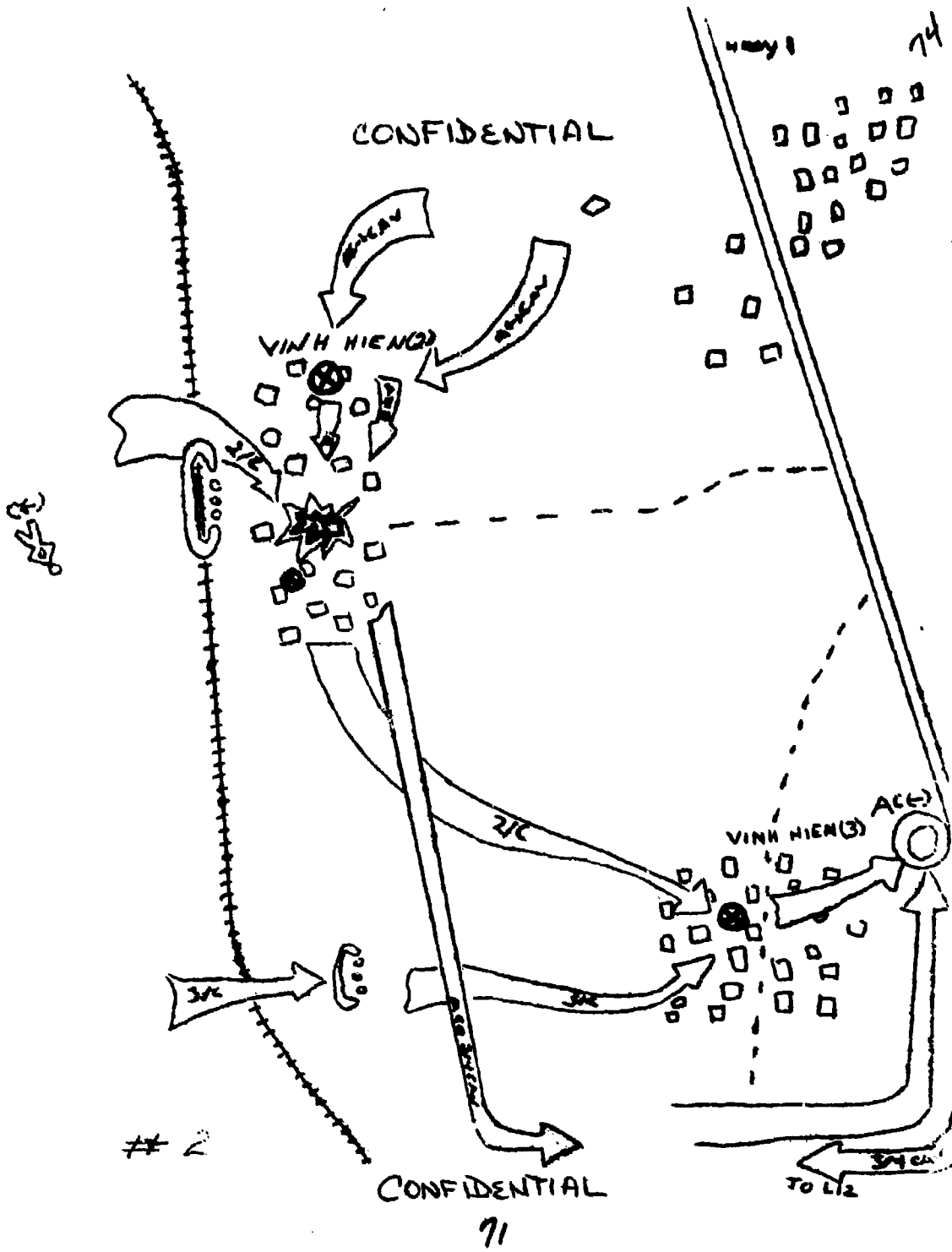

CONFIDENTIAL

5 August 1967

SUBJECT: Combat After Action Report for the period 19 thru 20 May 1967

Hien (3) toward Highway #1. After C Company had evacuated their wounded and dead, they moved into the northern part of Vinh Hien (3), paralleling A Company's route of movement. Just inside the hamlet, C Company encountered another entrenched enemy element. Helicopter rockets and small unit tactics eventually overcame the remaining VC force, and C Company established a combined perimeter in the paddy area east of the hamlet. See sketch # 2.

C/3/4 Cav had begun a sweep back toward the blocking position of the recon platoon. At 2015H, Recon/2/35 and C/3/4 Cav (-) closed LZ LIZ to provide FSB security. There were no further incidents that night. An armed AC-47 "Dragonship" reported on station at 2015H and his fires were directed by CPT Lanning. Artillery was fired into the hamlet throughout the night to deny the enemy access to the remnants of the battle area.

At 210620H, the two companies began a systematic search of the hamlet and other areas of contact. In addition, before the village was destroyed each and every bunker, spider hole, and hut was methodically searched for signs of the enemy. By the time the hamlet had been razed, all enemy material had been evacuated or destroyed. One ton of explosives was used to destroy the complex.

1. Results:

(a) Friendly Losses:

1 KIA.....5
2 WIA.....24

2. Enemy Losses - Personnel

(a) KIA.....89
(b) CIA.....3
(c) Detained (suspects).12

3. Enemy Losses

(a) weapons.....17
(b) mixed ammunition...10,000 rds
(c) rice.....1,000 lbs

72

CONFIDENTIAL

2ND BATTALION 35TH INFANTRY OPERATIONS

5 August 1967

SUBJECT: Combat After Action Report for the period 27 May thru 30 May 1967

THE BATTLE OF TAN PHONG

At 271200H, the battalion CP was notified by the S2, 3d Brigade Task Force, of a suspected enemy CP located in Tan Phong Hamlet, Duc Pho District, Quang Ngai Province, (BS735435). Since the organic forces of the battalion were committed some distance from the area of interest, the battalion commander, LTC Granger, requested and received permission to insert the Blue Team, Troop B, 1st Squadron 9th Cavalry, (Airmobile). The Blue Team, (an infantry platoon) was inserted by combat assault east of the target into an LZ vic BS739435, at 1255H. Team Penn (C/3-4 Cav (-) and the reconnaissance Platoon 2-35 Inf) located about ten kilometers north of LZ LIZ was given the mission of reserve reaction force (RRF) for the Blue Team to their south.

At 1300H, vic BS738439, the Blues reported observing thirty well armed and equipped enemy with camouflaged uniforms. The Blues engaged the enemy platoon, killed three and called for additional troop support to block what appeared to be a withdrawing enemy. Team Penn, reacting to the call, immediately moved south to block. Gunships from the weapons platoon B/1-9 Cav (Red Team) were dispatched to provide additional fire support. Artillery blocking fires were adjusted to the west of the contact to prevent enemy withdrawal in that direction. See sketch # 3.

At 1340H, B/2-35 was released from OPCON B/1-9 Cav and returned to the 2/35 Inf. They were alerted to move by air to support the growing fight. At 1400H, the Blues had secured an LZ vic BS747472, and the lift ships carrying 1B/2-35 were enroute. At 1402H, the first helicopter carrying 1B landed amidst very heavy enemy fire. The other five helicopters were forced to circle out of the area of contact. One ship was hit and the pilot wounded. Despite his wounds, the pilot was successful in landing his aircraft out of the battle area, 800 meters west of LZ LIZ. Recon (-) and two APC's from C/3-4 Cav were dispatched from LZ LIZ to provide security for the ship. By 1415H, the Blues, heavily engaged and suffering not only battle casualties but also heat casualties, had requested an emergency resupply of ammunition and water. At 1430H, a 174th Aviation Company HU-1D was loaded and over the area of contact at an LZ secured by the Blue Team. As the helicopter was making its approach it was hit by a heavy burst of enemy automatic weapons fire and subsequently crashed 200 meters south of the LZ. A squad of Blues successfully extracted the wounded crew from the burning craft before it exploded.

At 1545H, Company B (-) was airlifted to the vicinity of the downed bird where it linked up with the remaining elements of Recon and C/3-4 Cav. This force then deployed northwest to the hamlet where the Blues were heavily engaged and surrounded.

By 1607H, Team Penn had arrived from the north and was receiving fire from the enemy. Dismounting the battalion reconnaissance platoon, 3/4 Cav moved about one thousand meters west and attacked from the northwest. Recon assaulted the enemy from the northeast. See sketch # 3. The enemy, now engaged from three sides, found himself surrounded. They still persisted in their violent attack on the Blue Team and despite accurate gunship fire were able to inflict a few more casualties. As the pressure grew more intense, the enemy slackened their rate of fire and began to evade. The Recon platoon broke through the enemy lines

Inclosure 6

73
CONFIDENTIAL

INITIAL CONTACT

CONFIDENTIAL

77

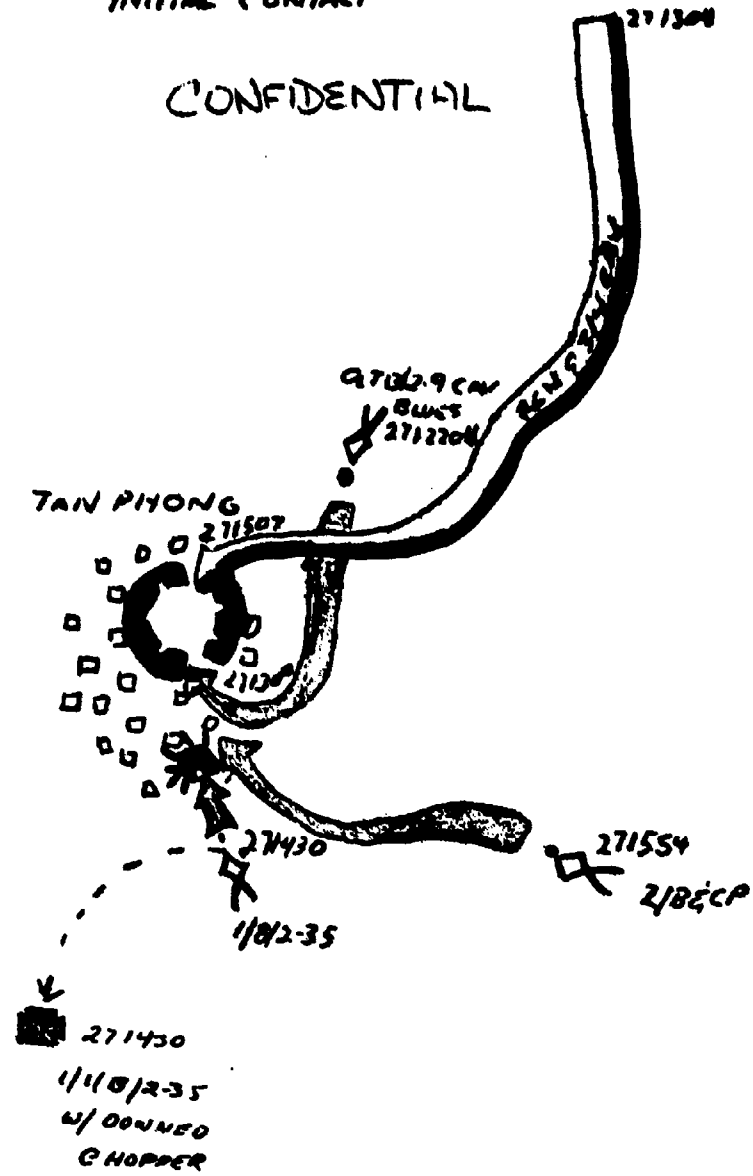

CONFIDENTIAL

3

74

CONFIDENTIAL

5 August 1967

SUBJECT: Combat After Action Report for the period 27 May thru 30 May

and linked with the Blues. See sketch #4. Almost simultaneously, the APC's, inflicting heavy enemy losses, broke through to the northwest. Captain Penn, CO, C/3-4 Cav, decided to withdraw the WIA's from the contact area to a secure LZ where the wounded could be evacuated. As his element with the WIA's in the APC's moved through the perimeter, Captain Penn's tracks became surrounded. The enemy undoubtedly thought they could stop the armor with their small arms but they paid a huge price in lives before they discovered their error. The armored cavalry succeeded in securing an LZ and at 1620H, the first DUSTOFF was completed.

At 1631H, B/2-35 (-) linked up with the friendly elements in the contact area (Tan Phong). After reorganization of the force, B Company deployed to the north for a careful, detailed search for the enemy. Finding the enemy was not difficult as they continued to resist with heavy volumes of small arms and automatic weapons fire. However, the enemy began using the many spider holes and caves that infested Tan Phong in an effort to escape the closing force. As the units approached the northern end of the hamlet, an airstrike was called in by LTC Granger on an enemy hamlet 500 meters north of Tan Phong. C/3-4 Cav was directed to move to the northwest in an attempt to move around the enemy and block his withdrawal. In the meantime, Recon began receiving moderate fire from the south, indicating the enemy had left a force behind. The Reconnaissance Platoon turned back through Tan Phong while B/2-35 (-) continued to the hamlet's northern fringe. By this time the large enemy force (estimated company (+)) had scattered and the units were receiving only light resistance. See sketch #5.

By 1900H, all elements closed in a perimeter vic BS730437, to be resupplied and to extract the Blue Team. 2B was to be lifted in to replace the team. At 1918H, 2B attempted a touchdown but again only one bird was able to land in the face of enemy AW fire. It was decided that it was too risky to try the exchange. Gunships, flareships, and an armed AC-47 reported on station. See sketch #6.

At 2100H, A/2-35 was airlifted from the beach to LZ LIZ where they assumed responsibility for FSB security. All elements dug in for the night.

At 280315H, the force in Tan Phong came under a light enemy mortar attack. Captain Penn, CO C/3-4 Cav, the only casualty, was mortally wounded. Counter-mortar fires from LZ LIZ and artillery fires by 2nd Bn 9th Arty were placed effectively throughout the area. There was no further contact that night. In view of the enemy strength it was decided to commit further troops into the area in the morning.

At 280938H, May 1967, C/1-35 (-) was placed OPCON 2-35 Inf and conducted a heliborne assault vic BS727477. Their assigned mission was to sweep south along the base of the hill mass on the western border of the coastal plain, a likely avenue of withdrawal. Recon/2-35 conducted a heliborne assault at 1055H west of C/1-35 (-) BS715465 and was assigned to sweep the ridge lines and draws in the hill masses to the northwest of Tan Phong. A/2-35 departed LZ LIZ on a sweep to the west not only to aid B/2-35 in the search of the battlefield, but also to establish contact. C/3-4 Cav was assigned blocking positions southeast of Recon. The Blue Team was extracted and replaced by 2B at 0916F. See sketch #7.

The simultaneous sweeps of the Tan Phong area on the 28th produced several small contacts. However, fire support by the gunships of the 174th Aviation Company and B/1-9 Cav (Airmobile) accounted for the vast majority of the enemy dead.

CONFIDENTIAL

2

75

CONFIDENTIAL

LINK UP AT THE FRONT AT 2200H MAY 68

79

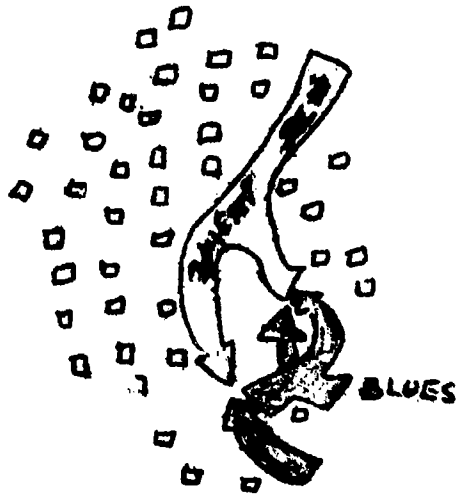

CONFIDENTIAL

4

76

CONFIDENTIAL

80

ASSAULT AND SWEEP OF TAN PHONG
AT 274631

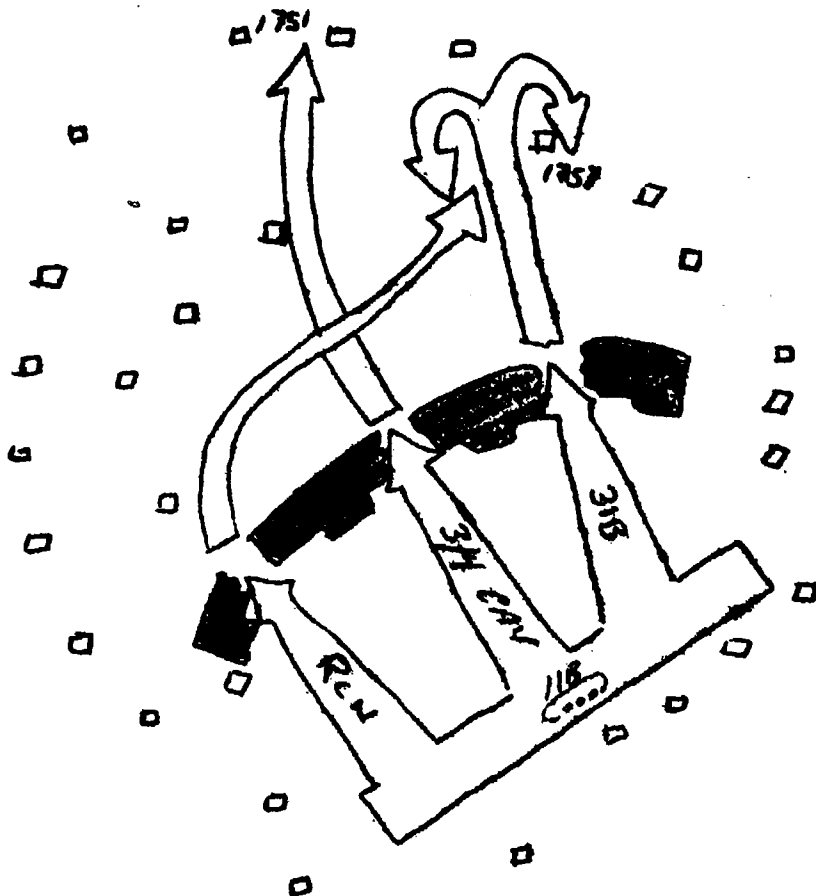

77

CONFIDENTIAL

#5

81

CONFIDENTIAL

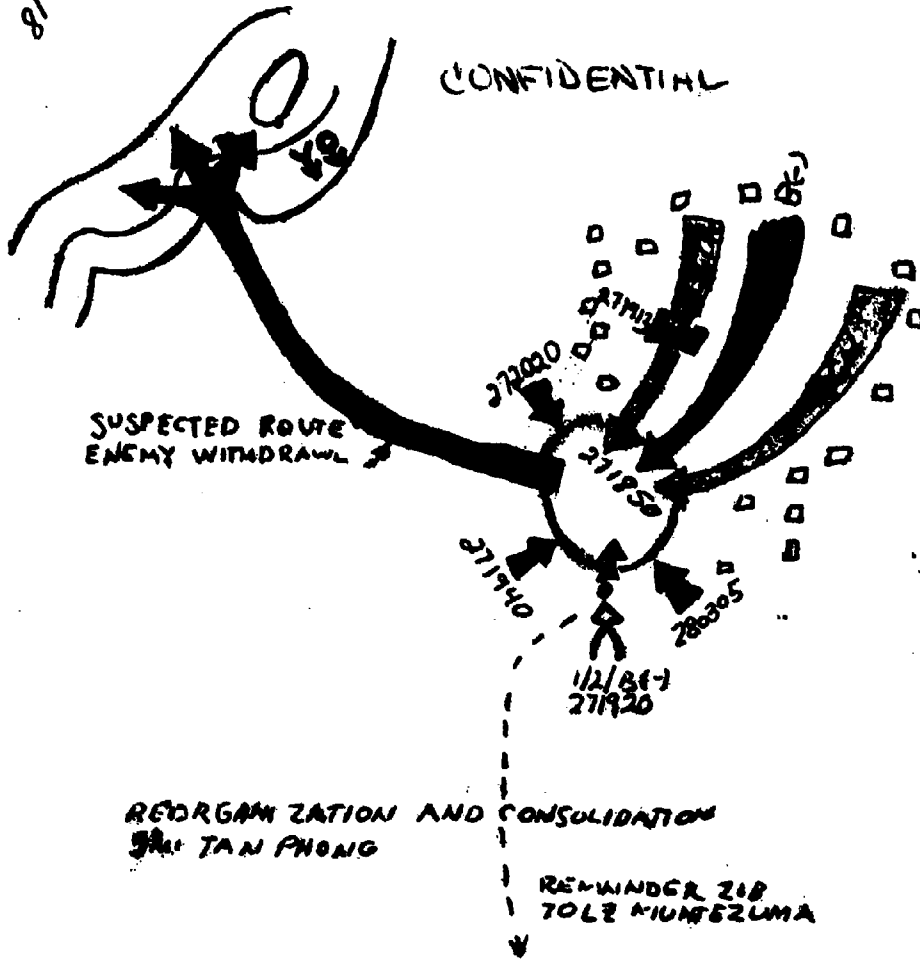

SUSPECTED ROUTE
ENEMY WITHDRAWAL

REORGANIZATION AND CONSOLIDATION
AT TAN PHONG

REWINDER 218
70 LZ MIANGSZUMA

CONFIDENTIAL



#6

78

CONFIDENTIAL

5 August 1967

SUBJECT: Combat After Action Report for the period 27 May thru 30 May 1967

A prisoner and a Hoi Chanh identified the enemy unit as the 60th Bn 1st VC Regiment. Undoubtedly, the majority of the battalion was in the area. As the 2-35 Inf elements pursued the enemy, they forced him to break into the clearings and rice paddies. The rockets and machinegun fire of the armed Hueys killed or wounded all observed enemy. The units on the ground forced the enemy into hiding to avoid the increasing onslaught. Efforts to capture prisoners failed as the enemy repeatedly fought to the death. By the end of the day, 87 enemy lay dead on the battlefield, killed for the most part by the gunships. A/2-35 and C/3-4 Cav swept back to LZ LIZ where they provided FSB security. Recon/2-35 was placed OPCON to B/2-35.

By 2215H, all elements were in position. B/2-35 with OPCON of Recon occupied four ambush sites at the mouth of the Song Tra Cau Valley: Recon located vic BS713424; 2B located vic BS712425; B (-) located vic BS713433; and 3B located vic BS715438. C/1-35 had three ambushes north of highway 515 positioned along the road. See sketch #7.

At 290240H May 1967, the ambush of Company B (-), located vicinity BS713433 came under intense enemy ground and mortar attack. See sketch # 8. Using camouflage and stealth, at least one enemy company surrounded the ambush position undetected. The enemy initiated the attack with accurate mortar fire. Efforts to counter the mortar fire with their own 60mm mortar and the 4.2 mortar platoon from LZ LIZ proved useless. The enemy was using at least two mortars which could not be located. As the mortars were raining their deadly fire, the enemy began a coordinated ground attack. Captain Ralph L. Walker, CO Company B, although mortally wounded by the initial mortar attack, rallied his men into a perimeter and requested artillery fire support. His courage and determination provided the catalyst for the initial defense of the position and undoubtedly prevented the unit from being overrun. Captain Walker died forty minutes later. When the unit moved from its linear ambush into a perimeter it inadvertently closed around an enemy position. The two enemy were swiftly killed. At 0300H, Medevac was requested to come to LZ LIZ where it would remain on alert until the contact area was secure. At the same time the aircraft commander of the armed AC-47 "Dragonship" reported that he would be in the area of contact at 0320H. Armed UH-1Cs were on station with a helicopter flare ship and began firing under the guidance of the 2nd platoon leader, who had assumed command. The enemy continued to fire his mortars although the volume was not as heavy. Efforts to locate these mortars proved fruitless. It was later discovered that the enemy had used a mud hut as a firing pit. A hole two feet in diameter was cut in the roof through which he fired his rounds. This tactic prevented observation of the muzzle flash and because of the muffled noise, made it virtually impossible to determine with accuracy how far away the mortars were. Meanwhile, the gunships concentrated their fire on ten enemy in a rice paddy. As the enemy attack intensified, the men from B Company threw white phosphorus grenades to mark the proximity of an enemy automatic weapons position. This enabled the armed helicopters from the 174th Aviation Company and B/1/9 Cav (Airmobile) to engage the enemy accurately. At 0325H it was decided to move the rest of B Company and the Reconnaissance platoon to reinforce the besieged platoon. At 0346H, LTC Granger, over the contact area in his command and control helicopter, decided to commit C/2/35 (-) in a reinforcing action from the east. All elements, as they moved toward the point of contact, made light contact which resulted in several more enemy dead. At 0405H, a medevac helicopter carrying the company executive officer successfully made it into the perimeter and evacuated three wounded. On its

CONFIDENTIAL

3
79

83

06Z 011-35 280975

CONFIDENTIAL

PURSUIT INTO WESTERN VALLEY
AND AMBUSH LOCATIONS

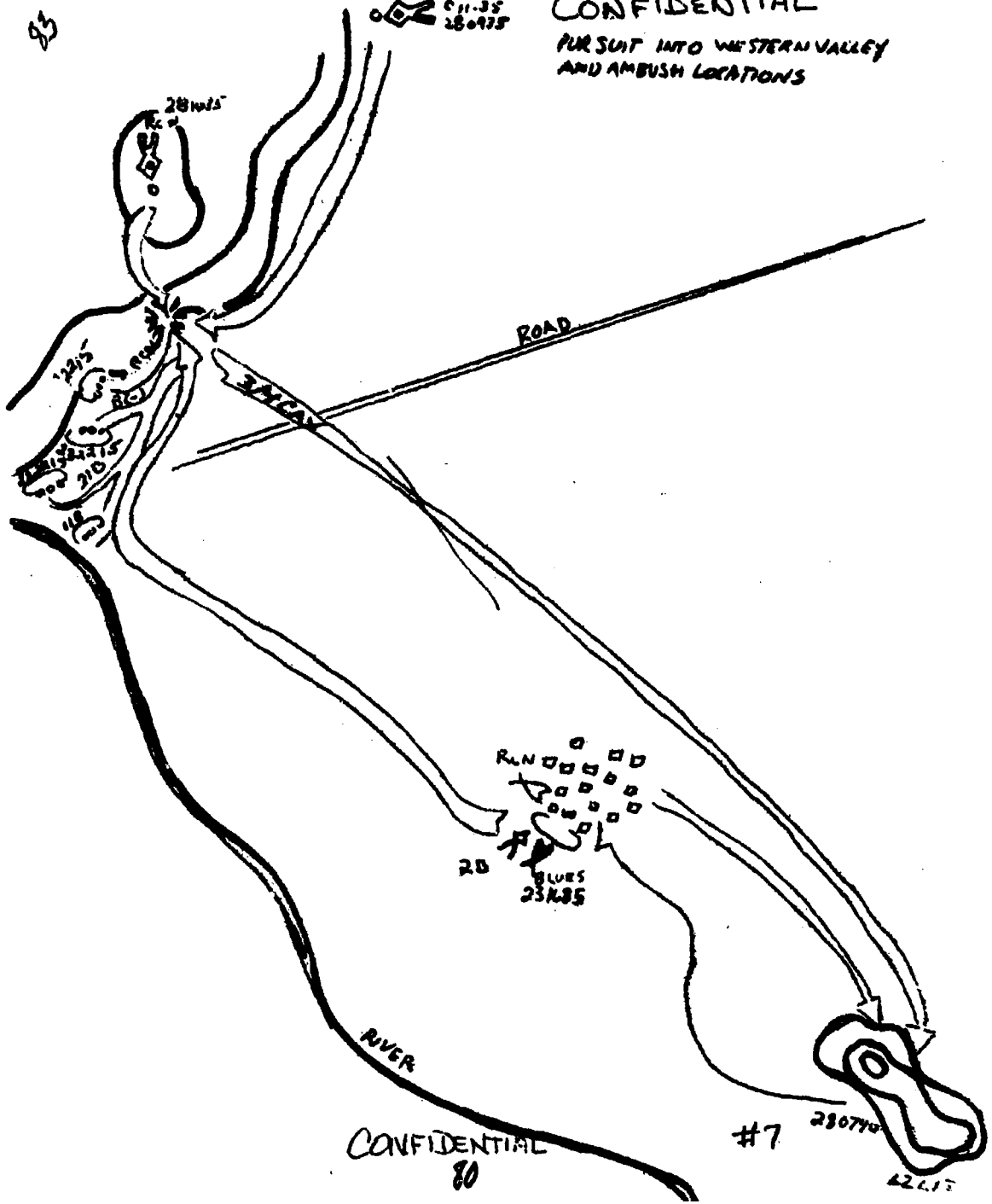

CONFIDENTIAL
80

#7 290770
42617

CONFIDENTIAL

ENEMY ATTACK OF
COB AMBUSH

84

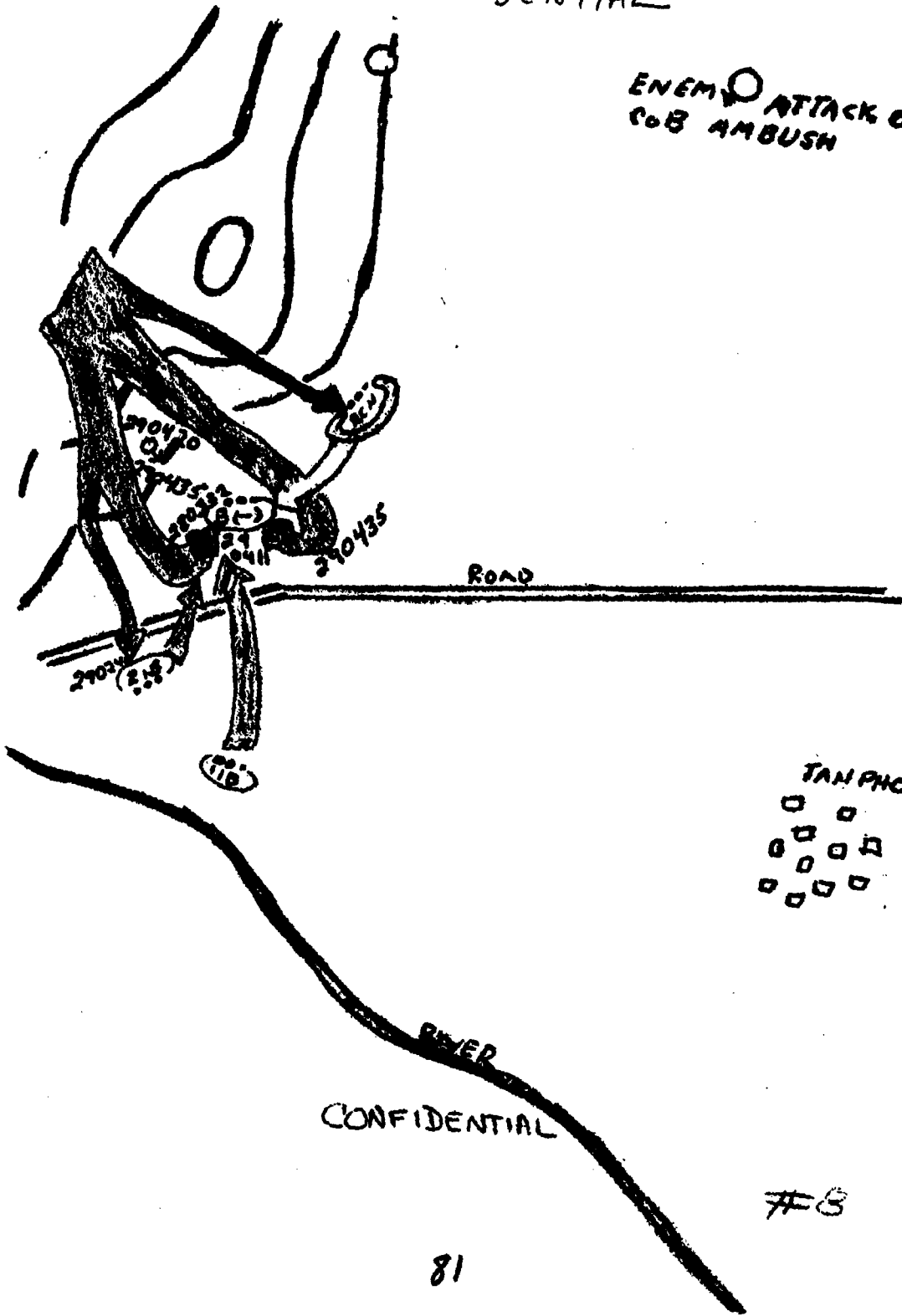

CONFIDENTIAL

#B

81

CONFIDENTIAL

5 August 1967

SUBJECT: Combat After Action Report for the period 27 May thru 30 May 1967

1
82

arrival 1Lt Russel Chapman assumed command. The departure of the medevac signaled a renewed enemy attack. At 0401H 1Lt Chapman was wounded in the head, but courageously continued in command. At 0411H, Recon and 1B attempting to break through the attack from the southwest came under intense automatic weapons fire. Maneuvering against the position, the reconnaissance platoon overran it and captured a .30 cal. 16 machinegun. This was the last strong effort made by the enemy to block the relief force. At 0434H, the enemy tried for the last time to break through the units staunch perimeter. He assaulted in mass from the east under a murderous barrage of enemy mortar fire. Some of the enemy broke through the lines and into the perimeter but that is where they died. Orders were issued that no one would leave their foxholes so that if anyone was seen moving in the perimeter he would be enemy. The tactic worked. At 0446H, the contact had lightened considerably. A medevac arrived over the area and landed in the LZ amidst suppressive fire from the perimeter. By 0550H, all contact had been broken by the enemy, the casualties had been evacuated and a resupply of ammunition had been effected. At 0617H, C/3/4 Cav, with one platoon A/2/35 departed LZ LIZ on two separate axes to the west to sweep the flanks of the contact area and reestablish contact with the enemy. At 0627H, C/1/35 closed with B/2/35. See sketch #9.

At 0845H, B/1/9 Cav was placed OPCON 2/35 Inf. The Blue Platoon conducted a combat assault via BS694423 and moved east along the Song Tra Cau Valley into the prepared blocking positions of C/1/35 and C/3/4 Cav at the mouth of the valley floor. A/2/35 swept south and southwest of the point of contact detaining large numbers of military age males who were hiding in a Buddhist temple. They also discovered five tons of stored rice in the same temple. The remaining elements made light contact while flushing the Viet Cong from bunkers, caves, and tunnels.

At 1030H, Company B was extracted by helicopter and taken to LZ Montesuma where they met their new CO, Captain Lindsey. At 1800H, A/2/35, C/3/4 Cav, and Recon/2/35 closed LZ LIZ, C/1/35 closed to a night location about 800 meters west southwest of LZ LIZ.

At 300930H May 1967, C/1/35 crossed the Song Tra Cau River, the southern AO line, and was returned to the control of the 1/35 Inf.

Results of the three day contact were as follows:

(1) Friendly casualties:

3 KIA
27 WIA
1 DOW

(2) Enemy losses, personnel:

116 KIA
8 CIA
119 Detained

(3) Enemy losses, weapons:

Gren. Berbed: 7
60mm mortar w/sight.....1
B-40 rocket launcher.....1
RPD IMG.....3
cal 30 IMG.....1
57 recoilless rifle.....1

82

CONFIDENTIAL

CONFIDENTIAL

96

5 August 1967

SUBJECT: Combat After Action Report for the period 27 May thru 30 May 1967

Individual: 34

Carbine, M-1 .30 cal.....3
Carbine, M-2 .30 Cal.....2
7.62 SKS.....10
AK-47.....6
BAR.....3
M-79, 40mm.GL.....3
SMG, Type unknown.....3
Pistol, 9mm.....1
7.62, Soviet Carbine, . . .
Mosin Nagant.....1
7.62, SMG, PPSH-41.....1
7.62, M-14.....1

83

5

CONFIDENTIAL

CONFIDENTIAL
U.S. COUNTERATTACK

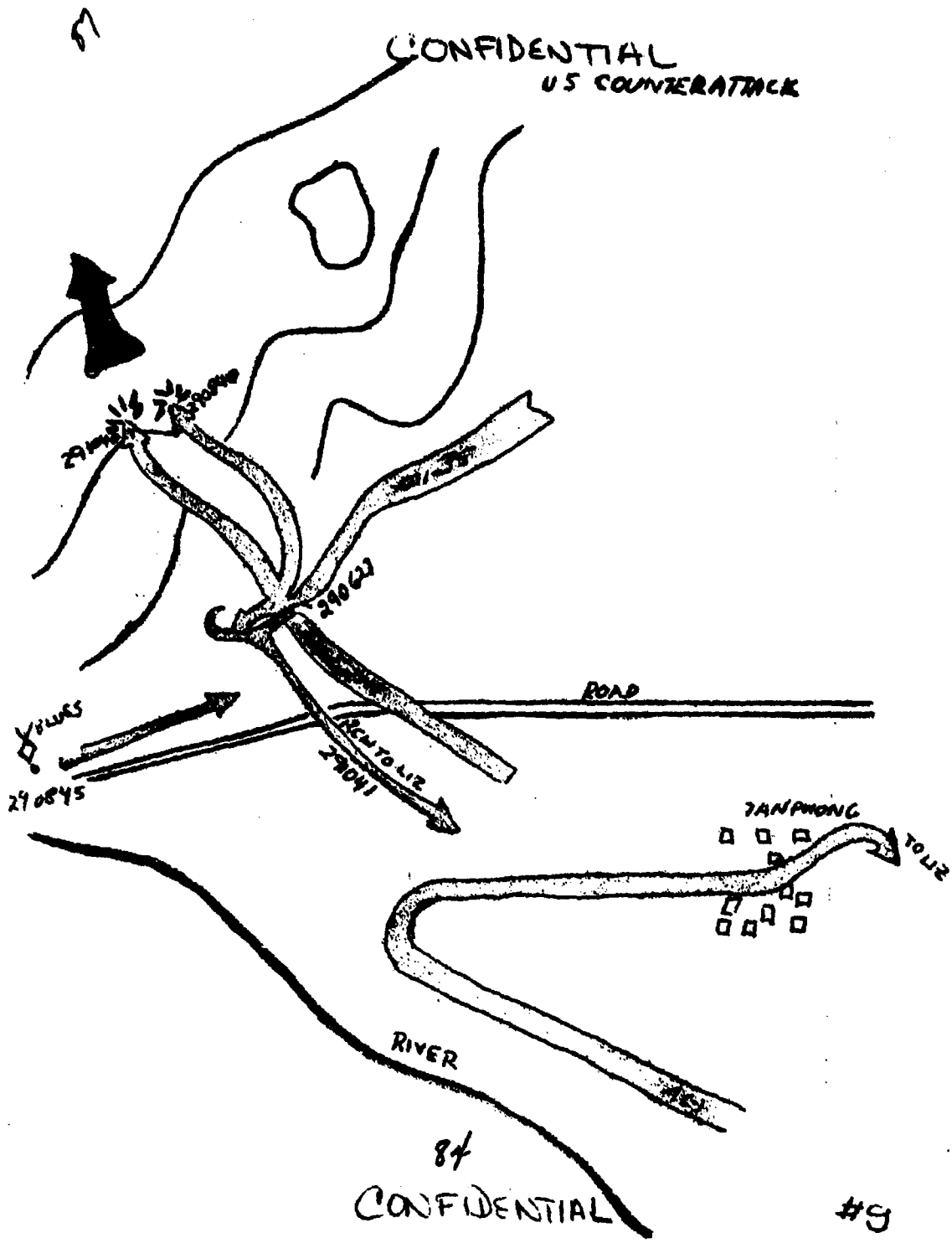

UNCLASSIFIED

Security Classification

DOCUMENT CONTROL DATA - R & D

(Security classification of title, body of abstract and indexing annotation must be entered when the overall report is classified)

1. ORIGINATING ACTIVITY (Corporate author)		2a. REPORT SECURITY CLASSIFICATION	
OACSFOR, DA, Washington, D. C. 20310		Confidential	
		2b. GROUP	
		4	
3. REPORT TITLE			
Operational Report - Lessons Learned, Headquarters, 3d Brigade, 25th Infantry Division			
4. DESCRIPTIVE NOTES (Type of report and inclusive dates)			
Experiences of unit engaged in counterinsurgency operations, 1 May - 31 July 1967			
5. AUTHOR(S) (First name, middle initial, last name)			
CG, 3d Brigade, 25th Infantry Division			
6. REPORT DATE		7a. TOTAL NO. OF PAGES	7b. NO. OF REFS
10 August 1967		85	
8a. CONTRACT OR GRANT NO.		8b. ORIGINATOR'S REPORT NUMBER(S)	
a. PROJECT NO.		670701	
c. N/A		8c. OTHER REPORT NO(S) (Any other numbers that may be assigned this report)	
d.			
10. DISTRIBUTION STATEMENT			
11. SUPPLEMENTARY NOTES		12. SPONSORING MILITARY ACTIVITY	
N/A		OACSFOR, DA, Washington, D. C. 20310	
13. ABSTRACT			
85			

DD FORM 1473
1 NOV 65

UNCLASSIFIED